

HYDAC INTERNATIONAL

Custom Engineered Hydraulic Cylinders and Cylinder Systems

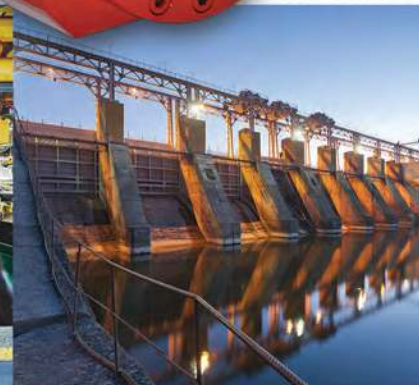

CYLINDER MANUFACTURING EXPERTISE

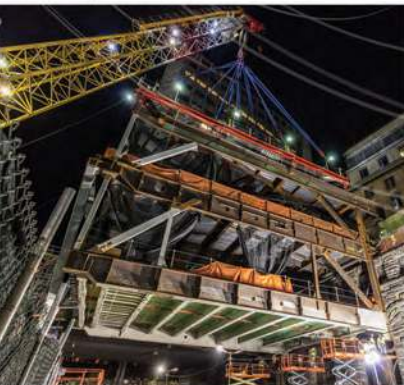

HYDAC's North America **CYLINDER DIVISION**, part of the global HYDAC Group, manufactures a broad range of custom engineered hydraulic cylinders and cylinder systems for mobile and industrial applications.

Advanced manufacturing technology with capacity to handle:

- Bore diameters up to 26 inches
- Strokes up to 400 inches
- Pressure up to 6000 psi

Core competencies and strengths:

- High speed machining with cutting-edge machine tool technology
- Manufacturing processes utilize computer aided manufacture control to ensure precision, quality and efficiency
- Structural Welding
- Welding standards that meet ASME BPVC Sect IX and AWS D1.1 Structural Welding Codes
- Product assembly with strict contamination control
- Static and dynamic functional pressure testing
- PLC controlled hydraulic testing equipment for pressures up to 10,000 PSI
- Paint coating system that includes surface pretreatment and high temperature curing
- Standard paint is black primer and has excellent compatibility for customer finish requirements. In addition, special coatings and finishes can be applied to meet customer requirements to resist harsh environmental conditions



American Welding Society



CYLINDER QUALITY ASSURANCE

Quality Process

- Our quality management system is certified to ISO 9001
- Quality control standards include material records, process control plans, manufacturing approvals and inspection data

Testing Standards

- All product undergoes 100% pressure testing 1.5 times the maximum allowable working pressure or to customer specifications
- Static and dynamic pressure testing
- Ultraviolet leak detection technology
- Petroleum, biodegradable and water glycol capable
- Non-destructive testing
- Coordinate measuring machine

Fluid Cleanliness

- 16/13 in accordance with ISO 4406
- Real-time monitoring and test phase documentation
- Independent sampling and oil diagnostic control



Your Partner for Cylinders and Cylinder Systems

HYDAC engineers are value creators. We are committed to solving problems and improving performance for our customers by drawing on HYDAC's vast experience with hydraulics and motion control design.

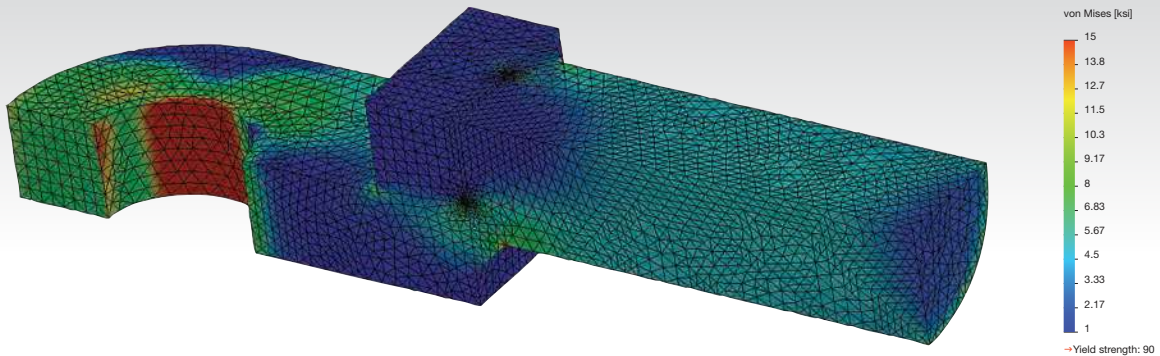

- Computer aided design
- 3 dimensional modeling
- Finite element analysis
- Non-linear stability calculations
- Structural and durability analysis
- Custom engineered sealing systems
- Extensive range of rod coating technologies
- Integrating solutions such as:
 - Mechanical immobilizers
 - Accumulators
 - Valves
 - Electronic position feedback
 - Stroke dampening
 - Proximity switches



CUSTOM HYDRAULIC CYLINDERS

HYDAC cylinders are designed to be reliable even in the toughest environments and applications. We offer a wide range of mounting, porting, sealing and coating solutions. Each design is carefully tailored to meet your specific needs.

Custom Designs for Bores up to 26" and Strokes up to 400"

- Single and double acting cylinders
- Double ended cylinders
- Differential cylinders
- Plunger cylinders
- Valve integrated cylinders
- Suspension cylinders
- Piggyback cylinders
- Multiple positioning cylinders
- Accumulator integrated cylinders
- Stainless steel cylinders
- Submersible cylinders

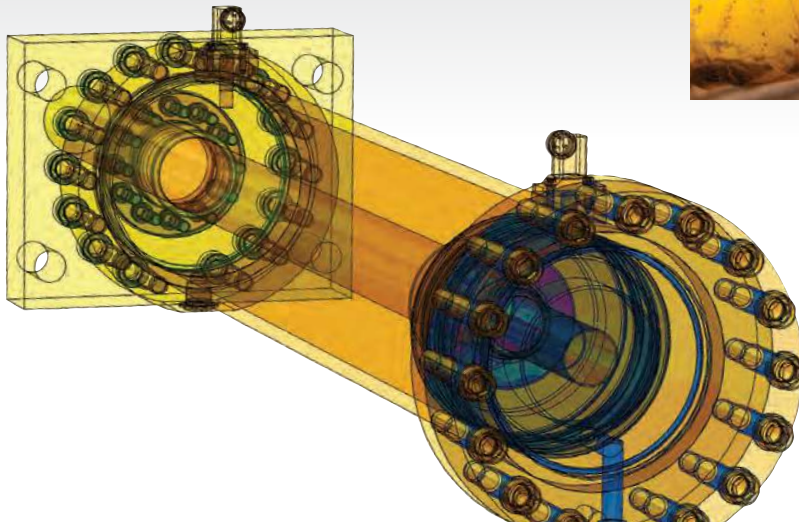

Excavator Cylinders

Excavators and mining machines depend on the linear actuation of hydraulic cylinders to provide motion and functionality. In this demanding application, HYDAC cylinders are designed to be robust, reliable and easily serviceable to achieve a high level of performance that our customers expect.



Heavy-duty construction grade cylinder

Road Construction Machinery

HYDAC supplies cylinders for road construction machinery which meets the strictest standards for durability and functional efficiency. The cylinders are tailored to make the best use of available space. These cylinders can be fitted with integrated valves, position sensors, pressure sensors, and an internal oil feed.

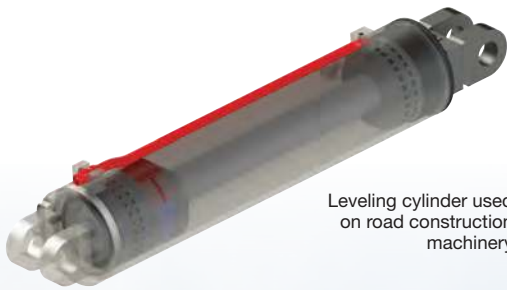

Leveling cylinder used on road construction machinery



Mobile Mining Machines

Hydraulic cylinders for mobile machines used in surface mining and tunnelling are put under challenging contamination and temperature conditions. Our cylinders are designed to be extremely robust to withstand such conditions. Appropriate materials are used along with special piston rod coatings, wipers, seals and guide systems to ensure a long service life.

Benefits and Special Features:

- Structurally durable design for dynamic application and high cycle rates
- Integrated position sensor technology
- Custom-designed piston rod coatings, seal and guide systems ensure a long service life.
- Vibration-resistant design
- Special sealing systems
- Integrated valve technology

Breakaway cylinder for blast hole drilling



Tensioner cylinder for mining machine

BOOM & OUTRIGGER CYLINDER SYSTEMS

HYDAC designs boom and outrigger vehicle cylinders to be lightweight in order to meet permissible axle load requirements, and to meet strict leak tightness and functional requirements.

Benefits and Special Features:

- High strength materials are used to minimize weight
- Customized seals prevent leakage
- Integrated valves (load holding and counter balance) provide space and weight savings
- Structurally durable designs ensure long life
- Corrosion resistant rod coatings assure durability

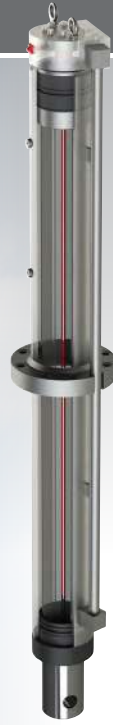

Outrigger cylinder with integrated HYDAC linear transducer



Three stage boom extend cylinder with integrated valves

CYLINDERS FOR CRANES

HYDAC manufactures hydraulic cylinders for mobile crane applications that allow for optimum crane design.

Benefits and Special Features:

- Minimal cylinder weight
- Flexible cylinder sizing
- Use of high strength materials
- Position sensors, valves, and other components can be integrated into the cylinder
- Anti-rotation piston rods are available



Lattice boom cylinder with integrated HYDAC directional control valve

STEERING & SUSPENSION CYLINDERS

HYDAC cylinders provide steering and suspension functions in many mobile applications. Our cylinders are designed with robust sealing systems and coating technology to endure harsh environmental conditions. We also supply hydraulic cylinders equipped with gas accumulators developed specifically to take into account your requirements with respect to suspension characteristics, forces and installation space.

Benefits and Special Features:

- Internal or external accumulator integration
- Low-friction design
- Position and pressure sensor systems
- Adjustable damping characteristics
- Rod coating tailored to suit operating conditions
- Low temperature seals are available



Steering cylinder with integrated position sensors



Suspension cylinder with integrated accumulator



INDUSTRIAL CYLINDERS

HYDAC produces a broad range of custom engineered cylinders with world-class quality and specialized features that excel in the world's most demanding industrial applications. From highly corrosive environments to steel mills, presses, complex machines and marine applications, our cylinders are the perfect choice to meet your needs.

Benefits and Special Features:

- Heavy-duty performance
- Corrosion resistance
- Advance sealing technology
- High strength materials
- Integrated solutions

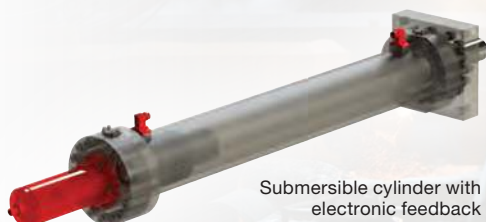

Submersible cylinder with electronic feedback

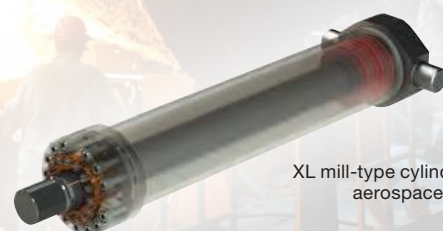

XL mill-type cylinder for aerospace press

To receive a quote, complete the Application Data Form and submit to your HYDAC Representative

Quote Due Date _____

CONTACT INFORMATION

Company Name _____

Contact Name _____

Phone _____

Email _____

Indicate One: Distributor End User OEM Other _____

SPECIFICATIONS

EAU: _____ Application: _____

Bore: _____ Stroke: _____ Rod Diameter: _____ Fluid Type: _____

Maximum Allowable Working Pressure: _____ psi OR Maximum Force Required: _____ psi

Tube Material Req.: _____ Rod Material Req.: _____

Cushion: _____ Port Type/Size: _____

Electronic Feedback Req.: _____ Third Party Certification: _____

Other Information: _____

DUTY

Operation: Compression Tension Both

Cycle Rate: _____ Life Cycles: _____

ORIENTATION

Mounting Type: Flange Trunnion Pin Eye Other _____

Cylinder Orientation: Vertical Horizontal Angle _____°

Known Side Load: _____

Degree of Misalignment (from Vertical): _____°

Other Information: _____

ENVIRONMENT

Environmental Temperature Range: _____°F min _____°F max Constant? Yes No

Conditions: Corrosive Abrasive Water Outdoor

Paint Requirements: _____

Other Information: _____

ADDITIONAL INFORMATION/REQUIREMENTS

Customer Drawing Available? Yes No

Other Special Requirements: _____

Global Headquarters
HYDAC INTERNATIONAL
GMBH

Industriegebiet
D – 66280 Sulzbach/Saar
Germany

Tel.: +49 6897 509-01

Fax: +49 6897 509-577

Internet: www.hydac.com
Email: info@hydac.com

HYDAC North America Locations

USA

www.HYDAC-NA.com

HYDAC TECHNOLOGY CORPORATION
Filter Division
2260 City Line Road
Bethlehem, PA 18017
+1.610.266.0100

HYDAC TECHNOLOGY CORPORATION
Accessory Division
2204 Avenue C
Bethlehem, PA 18017
+1.610.266.0100

HYDAC TECHNOLOGY CORPORATION
Electronic Division
Process Filter Division
HYDAC CORPORATION
Accumulator Division
90 Southland Drive
Bethlehem, PA 18017
+1.610.266.0100

HYDAC TECHNOLOGY CORPORATION
Filter System Division
Process Filter Division
580 West Park Road
Leetsdale, PA 15056
+1.724.318.1100

HYDAC TECHNOLOGY CORPORATION
Hydraulic Division
450 Windy Point Drive
Glendale Heights, IL 60139
+1.630.545.0800

HYDAC TECHNOLOGY CORPORATION
Mobile Hydraulic Division
1660 Enterprise Parkway • Suite E
Wooster, OH 44691
+1.610.266.0100

HYDAC CYLINDERS LLC
540 Carson Road North
Birmingham, AL 35217
+1.205.520.1220

HYDAC TECHNOLOGY CORPORATION
Cooling System Division
1051 Airlie Parkway
Denver, NC 28037
+1.610.266.0100

HYDAC TECHNOLOGY CORPORATION
Cooling System Division
445 Windy Point Drive
Glendale Heights, IL 60139
+1.630.545.0800

HYDAC TECHNOLOGY CORPORATION
HYDAC CORPORATION
Sales Office & Operations
1718 Fry Road, Suite 100
Houston, TX 77084
+1.281.579.8100

HYDAC TECHNOLOGY CORPORATION
HYDAC CORPORATION
NE Sales Office
1660 Enterprise Parkway • Suite E
Wooster, OH 44691
+1.610.266.0100

HYDAC TECHNOLOGY CORPORATION
HYDAC CORPORATION
SE Sales Office
1051 Airlie Parkway
Denver, NC 28037
+1.610.266.0100

HYDAC TECHNOLOGY CORPORATION
HYDAC CORPORATION
NW Sales Office
1201 NE 144th St. Bldg. B, Suite 111
Vancouver, WA 98685
+1.610.266.0100

HYDAC TECHNOLOGY CORPORATION
Hydraulic Division – Tech Center
430 Windy Point Drive
Glendale Heights, IL 60139
+1.630.545.0800

Canada

www.HYDAC-NA.com

HYDAC CORPORATION
14 Federal Road
Welland, Ontario, Canada L3B 3P2
+1.905.714.9322

HYDAC CORPORATION
Sales Office
Montreal, Québec, Canada J2M 1K9
+1.877.539.3388

HYDAC CORPORATION
Sales Office
5160 75 Street NW
Edmonton, Alberta, Canada T6E 6W2
+1.780.484.4228

Mexico

www.HYDACmex.com

HYDAC INTERNATIONAL SA de CV
Calle Alfredo A Nobel No 35
Col Puente de Vigas
Tlalnepantla, Edo Mexico
CP 54090
Mexico
+011.52.55.4777.1262