

# HYDAC INTERNATIONAL

## Filters

## Hydraulic & Lube Oil

Overview of Products

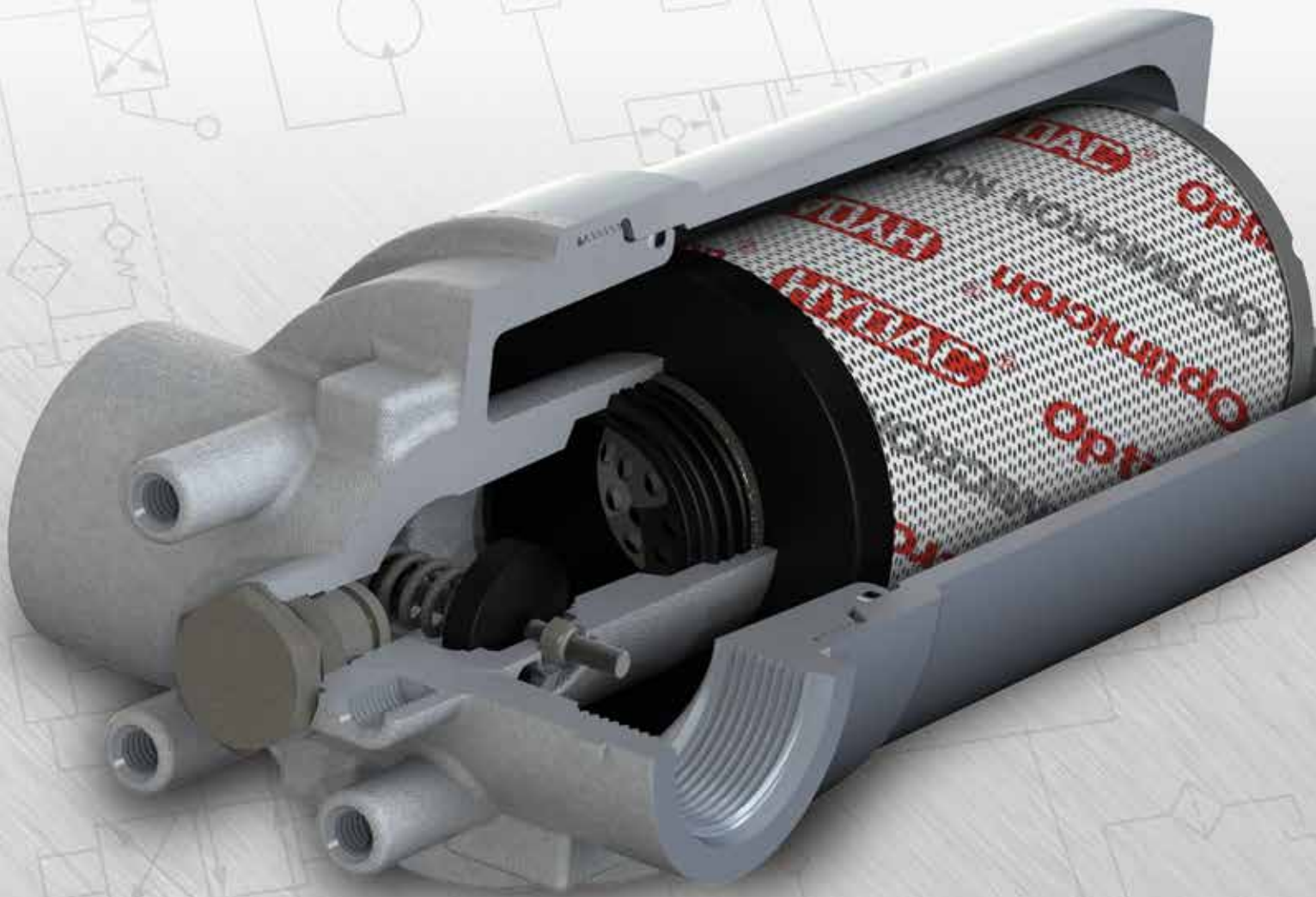



# Components, Systems and Service. All from one Company.

Our fluid engineering solutions are defined by the scope and complexity of our customers' requirements.

Our products range from individually designed components in the fields of fluid engineering, hydraulics and electronics right up to complete systems for specific functions.

All components and systems are conceived and designed in-house. Experienced industrial and product specialists develop innovative products and efficient solutions for high-quality, cost-effective production. Throughout the globe, our production facilities share one common goal: quality. We take great pride in both our products and solutions.

## Industries and Applications



**Overview of Filter Assemblies**

Introduction – A2; Contamination Control Fundamentals – A4; ISO 4406 Code – A8; Element Technical Data – A11; Element Selection – A13; Filter Selection – A15; Sizing Filter Assemblies – A17; Filter Applications Worksheet – A20

**A**

**Overview of Filter Elements**

**B**

**Filter Clogging Indicators**

Overview – C2; General Indicator Type Construction – C4; Standard Clogging Indicator Model Code – C5; Dual Gauge Blocks & Adapters – C7; Indicator Installation Information – C9

**C**

**Filter Quick Reference Guide**

**D**



**Filter Division**

2260 City Line Road  
Bethlehem, PA 18017  
+1.610.266.0100  
Internet: [www.hydac-na.com](http://www.hydac-na.com)  
Email: [HYD.catalog@hydac-na.com](mailto:HYD.catalog@hydac-na.com)

**NOTE**

Information and related materials are subject to change without notice. This catalog, and all information and related materials it contains, are provided “as is.” HYDAC makes no representation or warranty whatsoever regarding the completeness, accuracy, “up-to-dateness”, or adequacy of, the HYDAC-NA domain and this catalog.

## HYDAC – Your Partner for Performance, Reliability and Profitability

### Stat-X® Element Technology

#### Proven Performance for Critical Applications

Proven performance shows that **Stat-X®** is the only filter element technology capable of preventing electrostatic charging (ESC) and thus discharging (ESD) under any and all operating conditions, including:

- Low temperature cold start (T = 68°F/20°C)
- Extremely low oil conductivities (5 pS/m or less)
- High flow flushing operations
- Hydraulic loads well above 0.02 L/min/cm2 (cf. normal operation)

#### This results in:

- Reduction of oil degradation products (varnish)
- Increased oil service intervals
- Longer service life of bearings and prevention of bearing corrosion
- Safe operation in explosive atmosphere
- Reduction of unplanned downtimes
- Reduction of maintenance costs
- Longer maintenance intervals
- Maximum safety for employees and machines, due to proven reduction of electrostatic arcing



Our solution targets static electricity at the source thereby preventing costly performance reduction, equipment failure, varnish removal equipment investment, and serious safety hazards to both equipment operators and system components, thus improving overall safety and operating costs.



### Quality Protection

Ensures > Optimum performance and reliability, Predictable maintenance, Maximized revenue

HYDAC has developed quality protection features to safeguard critical machines from inferior aftermarket components. These components may appear to be a bargain, but in the end the user will have problems that they didn't bargain for – poor machine performance, equipment failure, unscheduled maintenance costs at potentially high labor rates, and costly downtime. The profits that were thought to be gained with these cost-cutting measures, evaporate quickly.

**HYDAC's solution** – Replacement elements with unique designs that are not easily pirated, which allows for both the protection of critical components and the retention of aftermarket business.

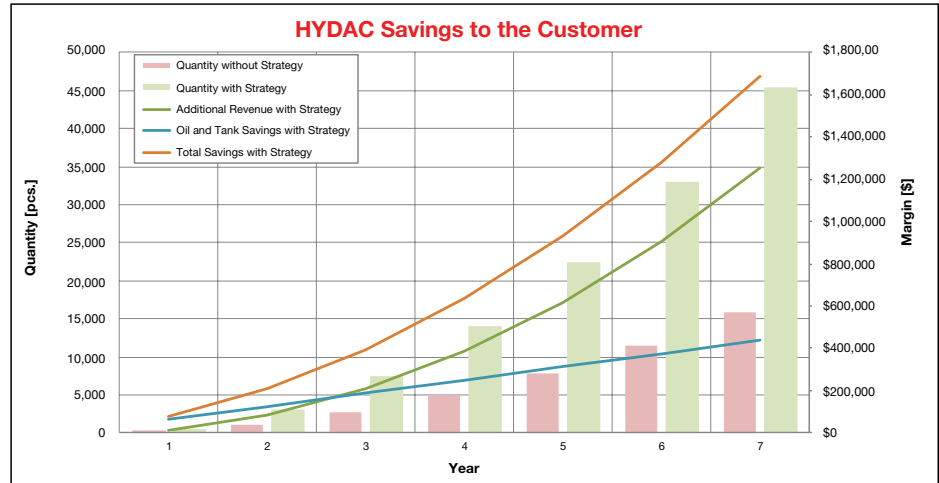

#### Filters Available with Quality Protection

<b>Low Pressure</b>	RFM	RKM	RF	NF	NFD	FLN	FLND	RFLD
<b>Medium Pressure</b>	LF	LPF	LPFH	MFH				
<b>High Pressure</b>	DF	HFM	MFM					

# Air Separation Technology

## Through innovative filtration and tank performance expert analysis

Industry trends emphasizing cost and space reduction have driven compromises in machine and tank design, which negatively impacts performance and reliability. At the forefront is an increase in air in hydraulic oil, primarily due to inadequate tank designs or improper tank sizing. In addition, seal leakage, cavitation, machine movement in operation, and inadequate filter-tank configurations contribute to air in hydraulic systems. It is of vital importance that the tank and filter be configured to deter aeration during operation and to provide a means for de-aeration.

The cost of air in oil:

- Noise
- Damage to components (cavitation)
- Accelerated oil ageing
- Increased Temperature
- Change in viscosity
- Oil leakage, foaming in the tank
- Decrease in filter performance



**Results in:** Losses in Efficiency, Controllability, Performance and Safety

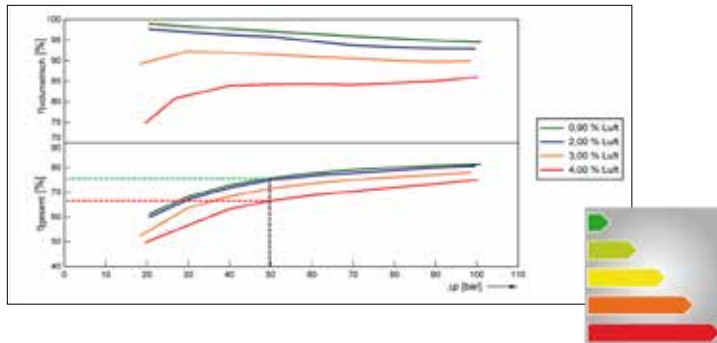

### HYDAC's Solution:

- 1) Innovative air separation filter designs
- 2) Tank performance analysis
- 3) Fluid Care Center (FCC): State of the art lab facilities to analyze filter and element performance in both static and dynamic conditions.
- 4) HYDAC Tech Center: The HYDAC Tech Center allows us to take a systems approach. Instead of focusing on individual products or components, we can instead study the overall system. Analyzing how these components function separately and together will result in the best design performance outcome. Real data, bring real results!



### Advantages

- Improved de-aeration - increased machine reliability
- Oil volume reduction - costing-saving, environmental-friendly
- Tank size reduction - material cost savings, increases available area for other components
- Simplifies tank fittings and connections - material and assembly cost savings

### FILTER-TANK MULTI-PHASE SIMULATION (Computer-aided optimization of tank systems)

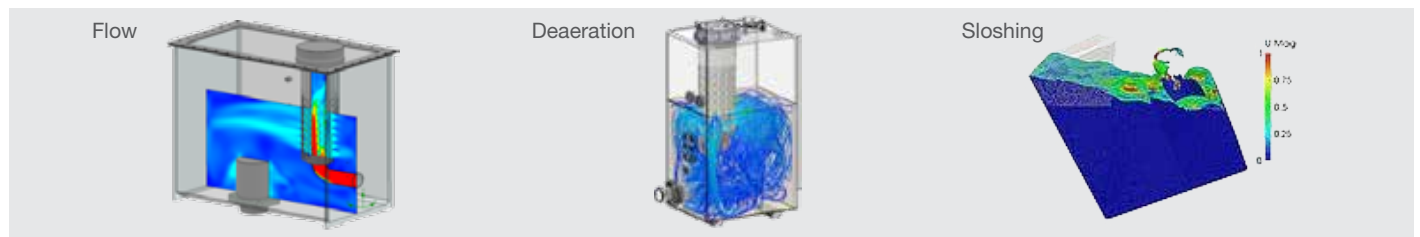

### LABORATORY TESTS

#### Characterization and validation under controlled conditions

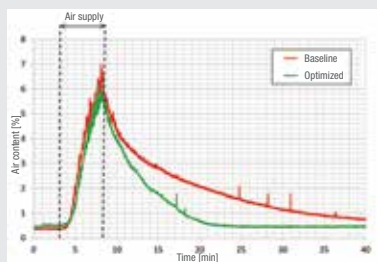

- Simulation - Tank system de-aeration performance
- Advanced air content sensor for quantitative characterization, optimization and validation of tank systems

### FIELD TESTS

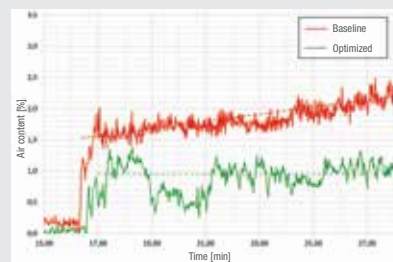

#### Characterization and validation under real working conditions

- Air content measurement in real world conditions
- Analysis - Influence of operating conditions on air content
- Final validation of optimized tank systems

# OVERVIEW

## Note to the Reader

The objective of our catalog is to provide the information and guidance you'll need to make informed and appropriate choices for your filtration needs.

Illustrated and easy to understand, Section 1 - Contamination Control Fundamentals serves as an effective "primer" on contamination control. In the following sections, we also provide filtration information and guidance for selecting the optimal filter and element media for your application.

**Section 1** explains recent changes in industry standards regarding how fluid cleanliness is defined and measured. Recent technological advancements in the measurement of microscopic particles, coupled with the establishment of a new standard test dust for calibration purposes, necessitated these changes. Although the new standards may seem confusing at first, they enable more accurate sizing of dirt particles and reduce variability in output among different automatic particle counters. The end result is more reliable data for the user.

**Section 2** details element technical data and selection criteria. Performance and element testing is described. Element selection to fit the application is addressed.

**Section 3** details filter selection considerations and provides procedures for selecting and sizing filters for system applications.

**Section 4** provides a detailed overview of HYDAC elements and their performance specifications.

**Section 5** you'll find extensive technical data on HYDAC's comprehensive collection of high efficiency depth (absolute) filter medias, which combine high efficiency performance with low pressure drop and exceptional dirt holding capacity. HYDAC's design engineers have also given special attention to developing more environmentally friendly products, such as Ecomicon® elements. These elements contain little or no metal and are made of fully recyclable materials for environmentally safe disposal.

## Visit Us Online...

HYDAC's web site, [www.hydac-na.com](http://www.hydac-na.com), now offers our Online Cross-Reference Guide to Betterfit® replacement elements titled **Betterfit Element Selector**. With this user-friendly guide you can match filter elements from many other manufacturers with appropriate HYDAC Betafit® replacements.



## ISO Certification

HYDAC is a worldwide leader in hydraulics. We have earned that role by emphasizing quality, innovation, and excellence in everything we manufacture. As an ISO 9001:2008 registered company, HYDAC is committed to maintaining high standards of quality and services.

### WARNING!



#### FAILURE OR IMPROPER SELECTION OR IMPROPER USE OF THE PRODUCTS AND/OR SYSTEMS DESCRIBED HEREIN OR RELATED ITEMS CAN CAUSE DEATH, PERSONAL INJURY AND PROPERTY DAMAGE.

This document and other information from HYDAC, its subsidiaries and authorized distributors provide product and/or system options for further investigation by users having technical expertise. It is important that you analyze all aspects of your application and review the information concerning the product or system in the current product catalog. Due to the variety of operating conditions and applications for these products or systems, the user, through its own analysis and testing, is solely responsible for making the final selection of the products and systems and assuring that all performance, safety and warning requirements of the application are met.

HYDAC does not assume the risk of and shall not be liable for failure due to fire. HYDAC offers fire safety devices and recommends their use.

The products described herein, including without limitation, product features, specifications, designs, availability and pricing, are subject to change by HYDAC Corporation and its subsidiaries at any time without notice.

## Corporate Overview

HYDAC focuses on the filtration needs of our customers in the fluid power industry and is proud of our proven track record of providing quality filtration products over the last thirty years. The designs you see in this catalog are the result of thousands of hours of field testing, laboratory research and decades of experience.

HYDAC is a leader in filtration and fluid conditioning and the proof of our expertise lies in our broad mix of quality products.

HYDAC's goal is to be your filtration partner. Our expertise in filtration technology, our superior filter and element manufacturing capabilities, and our dedication to customer service and product support are the reasons we are leaders in the Filtration Supply Industry.

We are committed to providing the best available filter products to meet system and component mandatory cleanliness levels at a competitive price. As a cost-effective quality producer, we can work with your applicable department to supply contamination control technology or develop long-range supply and pricing programs that can improve your company's bottom line.

HYDAC's products, technical expertise, commitment to research and development, and ongoing improvements in manufacturing enable us to provide products and services that improve performance and efficiency in many major industries, including:



## Capabilities

HYDAC has in place a strategically positioned international distribution network, supported by our professional and experienced sales and marketing team. Distributor personnel are trained in the important aspects of filter application by HYDAC in training sessions held at our factory and around the globe. The effectiveness of our product and service support is multiplied by utilizing HYDAC's extensive distributor network.

## Products

HYDAC's products are continually tested using the latest ISO, ANSI and NFPA test procedures in our contamination control lab. Our dynamic test stands are in constant operation, subjecting our filter housings to cyclic pressure to verify their rated fatigue pressures per NFPA Standard T2.6.1 or other international standards. Statistically sampled elements are tested to ensure fabrication integrity in the manufacturing process. They are also tested for efficiency, stability and dirt-holding capacity in a multi-pass test facility, equipped with characterization instruments with in-line particle counting capabilities, which are calibrated to ANSI standards. In addition, a flat media multi-pass test is used in our ongoing filter media development program.

Extensive testing is conducted to ensure compatibility with various hydraulic fluids, including the newest fire-resistant fluids, per ISO 2943 Standard. Flow fatigue tests are run to evaluate the structural strength of elements, per ISO 3724 Standard.

## HYDAC Standard Tests Design and Testing Standards of HYDAC Filter Housings

Description	Standard
Burst Pressure Test	NFPA/T-2.6.1
Fatigue Testing	NFPA/T-2.6.1
Pressure Drop vs. Flow	NFPA/T-3.10.14

## Design and Testing Standards of HYDAC High Efficiency Elements

Description	Standard
Element Collapse (Burst)	ISO 2941
Fabrication Integrity	ISO 2942
Material Compatibility	ISO 2943
Element Flow Fatigue	ISO 3724
Pressure Drop/Flow Rate	ISO 3968
Multi-Pass	ISO 16889

All HYDAC element manufacturing facilities have newly upgraded multi-pass test facilities capable of dynamic element performance testing to better simulate actual application cyclic flow variations.



## Section 1: Contamination Control Fundamentals

### Why Filter?

Seventy to ninety percent of all hydraulic system failures are caused by contaminants in the fluid. Even when no immediate failures occur, high contamination levels can sharply decrease operating efficiency.

Contamination is defined as any substance which is foreign to a fluid system and degrades its optimum performance. Contamination can exist as a gas, liquid or solid. Solid contamination, generally referred to as particulate contamination, comes in all sizes and shapes and is normally abrasive.

High contaminant levels accelerate component wear and decrease service life. Worn components, in turn, contribute to inefficient system operation, seizure of parts, higher fluid temperatures, leakage, and loss of control. All of these phenomena are the result of direct mechanical action between the contaminants and the system components. Contamination can also act as a catalyst to accelerate oxidation of the fluid and spur the chemical breakdown of its constituents.

Filtering a system's fluid can remove many of these contaminants and extend the life of system components.

**Filtration = System Protection / Management**

### How a System Gets Contaminated

Contaminants come from two basic sources: they either enter the system from outside (ingression) or are generated from within. New systems often have contaminants left behind from manufacturing and assembly operations. Unless they are filtered as they enter the circuit, both the original fluid and make-up fluid are likely to contain more contaminants than the system can tolerate. Most systems ingest contaminants through such components as inefficient air breathers and worn cylinder rod seals during normal operation. Airborne contaminants are likely to gain admittance during routine servicing or maintenance. Also, friction and heat can produce internally generated contamination.

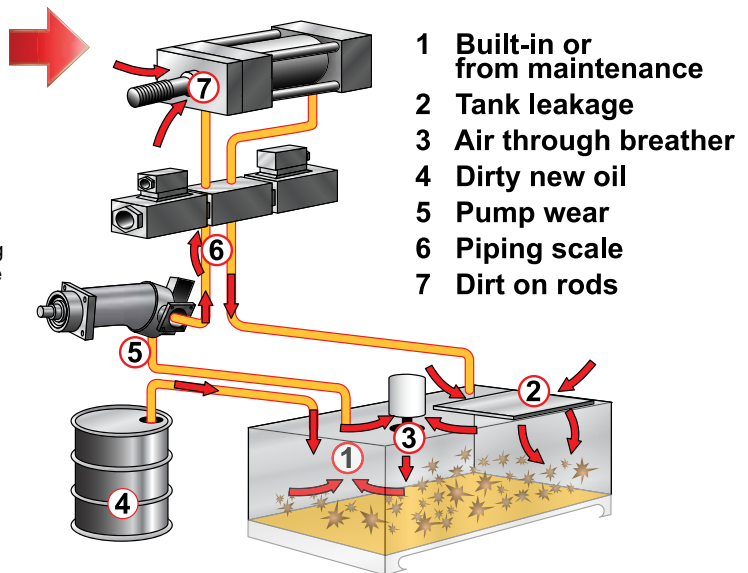

### Size of Solid Contaminants

The size of solid particle contaminants is commonly measured in micrometers,  $\mu\text{m}$ , (usually referred to as microns,  $\mu\text{m}$ ). A micron is a unit of length equal to one millionth of a meter or about 0.00004 inch. Particles that are less than 40  $\mu\text{m}$  cannot be detected by the human eye.

Figure 2 shows the sizes of some common substances. To gain some perspective, consider the diameters of the following substances:

Substance	Microns	Inches
Grain of table salt	100 $\mu\text{m}$	0.0039"
Human hair	80 $\mu\text{m}$	0.0027"
Talcum powder	10 $\mu\text{m}$	0.00039"
Bacteria (average)	2 $\mu\text{m}$	0.000078"

A micron rating identifies the size of particles that a particular filtration media is designed to remove. For instance, HYDAC 3  $\mu\text{m}$  Betamicon® filter media is rated at  $\beta_3 \geq 1000$  (also equivalent to the filter media average pore size), meaning that it can remove particles of 3  $\mu\text{m}$  and greater at 99.9% efficiency.

Figure 1. Typical Examples of Wear Due to Contamination





Figure 2. Sizes of known Particles in Inches and Microns

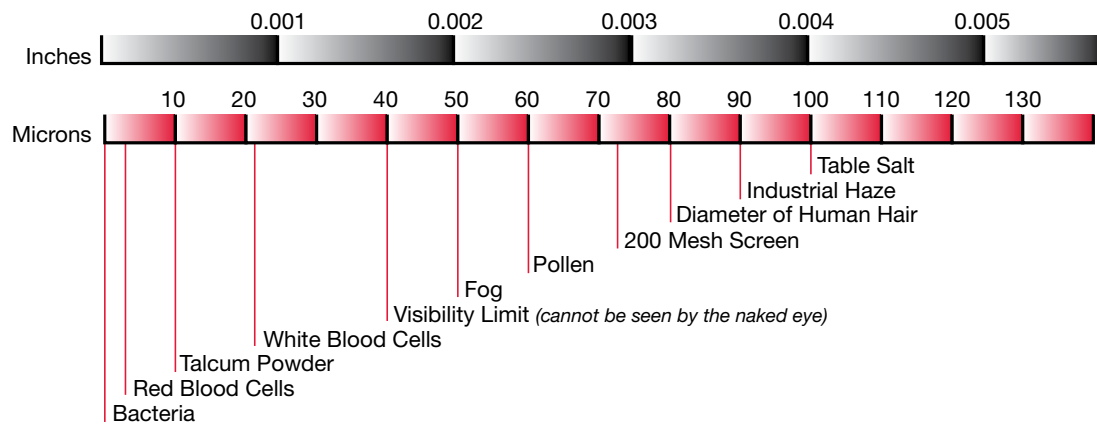

### How Contaminants are Measured and Reported - Changes in the Industry

In hydraulic fluid power systems, power is transmitted and contained through a liquid under pressure within an enclosed circuit. These fluids all contain a certain amount of solid particle contaminants. The amount of particulate contaminants present in a hydraulic or lubrication system’s fluid is commonly referred to as its cleanliness level.

In 1999, the International Standards Organization (ISO) introduced a series of new fluid cleanliness standards that reflect changes in measuring and defining the cleanliness of fluid systems and the way the size and amount of solid contaminants are reported. These standards are summarized in Table 1.

Table 1. Changes in Industry Standards

Previous	Current	1999	Description
ISO 4406	ISO 4406:1999	ISO	ISO Range Code
ISO 4402	ISO 11171	ISO	Automatic Particle Counter (APC) calibration procedures (ACFTD to ISO MTD)
ISO 4572	ISO 16889	ISO	Multi-pass test reports

The change in calibration procedures (ISO 4402 to ISO 11171) occurred for two reasons. First, the industry developed a new standard test dust for calibration fluid. This new ISO Medium Test Dust (ISO MTD) replaced the previously used AC Fine Test Dust (ACFTD), which is no longer available. Secondly, there has been a change in how particle sizes are measured. By way of newer technologies, particles are now measured in two dimensions, whereas in the past they had been measured using the largest dimension (chord). Older technology was not as precise as it is today, and particle sizes reported were less accurate. Table 2 shows that what used to be classified as a 2 μ particle is now classified as a 4.6 μ(c) particle. The (c) denotes that particle size measurements are certified using an Automatic Particle Counter (APC) which has been calibrated in accordance with ISO 11171.

ISO 11171 calls for the use of ISO MTD dust and changes the way we report the number of particles based on the new distribution of particles in the new standard reference material (SRM2806). Today, the ISO Medium Test Dust and the new calibration standard (11171) are used to synchronize all APC’s. This change was made in an effort to reduce variability in tests conducted in different laboratories around the world.

### How will these changes affect you?

In comparing the old standards to the new, the following have not changed:

- The amount and the size of solid contamination in your system is still the same!
- The filters still work the same way!

### What has changed:

The way particle size is specified has changed.

The new standards and reporting methods “move the measuring stick” to correct for the inaccurate calibration assumptions made.



# OVERVIEW

## Particle Size Definitions - ISO 4402 vs. ISO 11171

This change in the way contaminants are measured had the net effect of changing the classification of the size of the particle.

**Table 2. A Comparison of Particle Size Classification**

ISO 4402 (ACFTD)	ISO 11171 (ISO MTD)
< 1.0 µm	4.0 µm(c)
1.0 µm	4.2 µm(c)
2 µm	4.6 µm(c)
3 µm	5.1 µm(c)
5 µm	6.4 µm(c)
10 µm	9.8 µm(c)
15 µm	13.6 µm(c)
20 µm	17.5 µm(c)
25 µm	21.2 µm(c)
Previous Size per ISO 4402	Current Size per ISO 11171

Note that the size of the particles is reported differently; i.e., a particle 1.0 µm in size under ISO 4402 is now considered to be 4.2 µm(c) in size. **Keep in mind that the particles are actually the same size they have always been; we are just using a different ruler.**

## ISO Scale Numbers - ISO 4406 vs. ISO 4406:1999

ISO 4406:1999 provides guidelines for defining the level of contamination present in a fluid sample in terms of an ISO rating. Due to the change in the specification of particle sizes shown in Table 2, the definition of the ISO scale (or range) numbers needed to be redefined. Tables 3(a) and 3(b) provide a comparison of ISO scale numbers under ISO 4406 and 4406:1999, respectively.

Another change involved the addition of a third scale number to define an ISO rating. Under the old ISO 4406, the ISO scale numbers represented the number of particles greater than or equal to 5 µm and 15 µm in size. The new ISO 4406:1999 uses three scale numbers, representing the number of particles greater than or equal to 4 µm(c), 6 µm(c), and 14 µm(c) in size.

Figure 3(a) shows the graph used to plot particle counts per ISO 4406. When the count of particles  $\geq 5 \mu\text{m}$  and  $\geq 15 \mu\text{m}$  in size are plotted, the corresponding ISO rating can be determined graphically. Two micron (2 µm) levels are optional, as they are not a required part of the old ISO 4406 standard.

Similarly, Figure 3(b) shows the graph used to plot particle counts per ISO 4406:1999. This figure shows how 4406:1999 is different from the old ISO 4406 in that it plots the cleanliness level based on the number of particles at the 4 µm(c)/6 µm(c)/14 µm(c) sizes per 1 mL of fluid.

Also, filter companies previously measured the number of particles per 100 mL of sample fluid. Under ISO 4406:1999, we now report the number of particles per 1 mL of sample fluid.

It is important to note that net effect of all these changes keeps the ISO rating relatively unchanged.

Figure 3(a). Graphing Particle Counts per ISO 4406

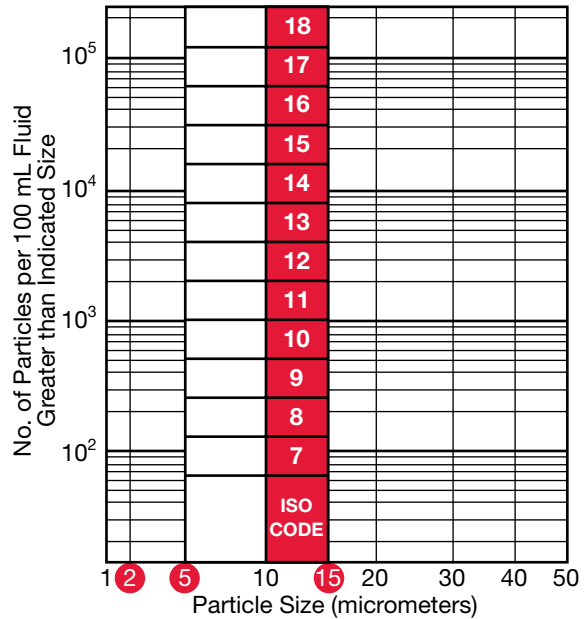
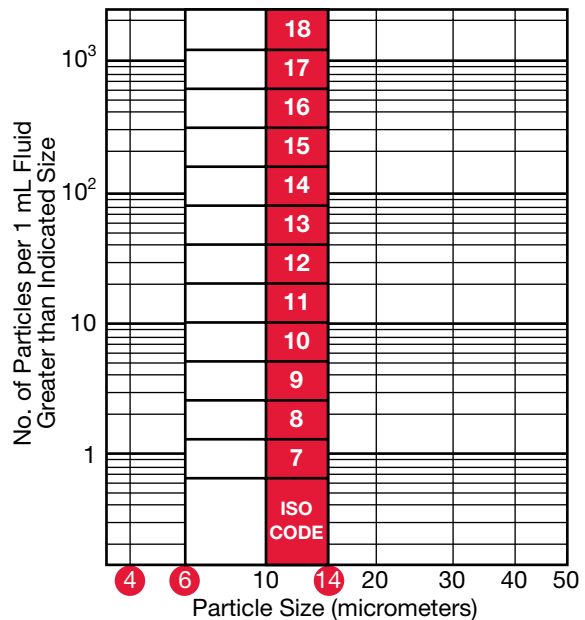

Figure 3(b). Graphing Particle Counts per ISO 4406:1999



## Particle Size Diameter Comparison

$$1 \mu\text{m} = 0.001 \text{ mm} = 0.000039 \text{ in.}$$

The human eye can only see particles sized down to 40 microns.



Table 3(a). ISO Code 4406 Hydraulic Fluid Power– Solid Contamination Code

Number of Particles per 100 mL of Fluid		Scale Number
More Than	Up to and Including	
8,000,000	16,000,000	24
4,000,000	8,000,000	23
2,000,000	4,000,000	22
1,000,000	2,000,000	21
500,000	1,000,000	20
250,000	500,000	19
130,000	250,000	18
64,000	130,000	17
32,000	64,000	16
16,000	32,000	15
8,000	16,000	14
4,000	8,000	13
2,000	4,000	12
1,000	2,000	11
500	1,000	10
250	500	9
130	250	8
64	130	7
32	64	6
16	32	5
8	16	4
4	8	3
2	4	2
1	2	1

Previous ISO codes are commonly made up of 2 scale numbers representing the number of particles  $\geq 5 \mu\text{m}$  and  $\geq 15 \mu\text{m}$ . Showing a third scale number,  $\geq 2 \mu\text{m}$  is optional. The left number will always be larger. The scale numbers are defined such that each successive scale is generally a doubling of the previous scale. The particle count can be expressed as the number of particles per mL or per 100 mL, but the ISO range numbers and the ISO codes do not change.

### What types of wear are there?

1. **Abrasion** caused by particles between reciprocating surfaces.
2. **Erosion** caused by particles and high fluid velocity.
3. **Adhesion** caused by metal-to-metal friction (loss of fluid).
4. **Surface fatigue** surfaces damaged by particles are subjected to repeated stress.
5. **Corrosion** caused by water or chemicals.

Table 3(b). ISO 4406:1999 Hydraulic Fluid Power– Solid Contamination Code (New)

Number of Particles per 1 mL of Fluid		Scale Number
More Than	Up to and Including	
1,300,000	2,500,000	28
640,000	1,300,000	27
320,000	640,000	26
160,000	320,000	25
80,000	160,000	24
40,000	80,000	23
20,000	40,000	22
10,000	20,000	21
5,000	10,000	20
2,500	5,000	19
1,300	2,500	18
640	1,300	17
320	640	16
160	320	15
80	160	14
40	80	13
20	40	12
10	20	11
5	10	10
2.5	5	9
1.3	2.5	8
0.64	1.3	7
0.32	0.64	6
0.16	0.32	5
0.08	0.16	4
0.04	0.08	3
0.02	0.04	2
0.01	0.02	1
0.00	0.01	0

Current ISO codes are made up of 3 numbers representing the number of particles  $\geq 4 \mu\text{m}(c)$ ,  $\geq 6 \mu\text{m}(c)$  and  $\geq 14 \mu\text{m}(c)$ . The particle count is expressed as the number of particles per mL.

### Example Effects of Abrasion:

- Changes to tolerances
- Leakage
- Reduced efficiency
- Particles produced in the system create more wear!

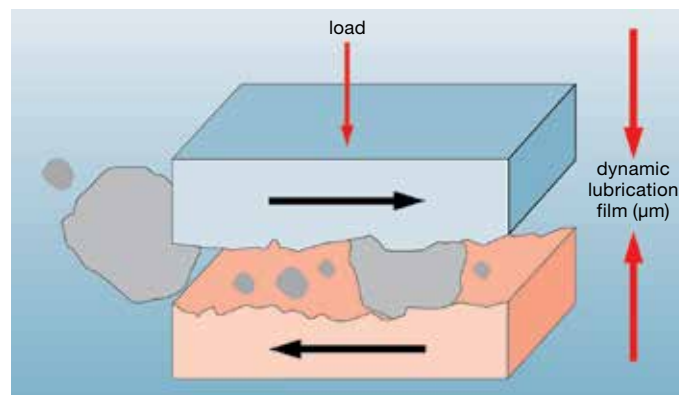

# OVERVIEW

## ISO 4406 Code

Cleanliness levels are defined by three numbers divided by slashes (/). These numbers correspond to 4, 6, and 14 micron, in that order. Each number refers to an ISO Range Code, which is determined by the number of particles for that size (4, 6, & 14µm) and larger present in 1 ml of fluid. Each range is double the range below. Refer to the chart below to see the actual ranges.

### Example:

larger than 4µm = 22,340

larger than 6µm = 1,950

larger than 14µm = 43

ISO Code = 22 / 18 / 13

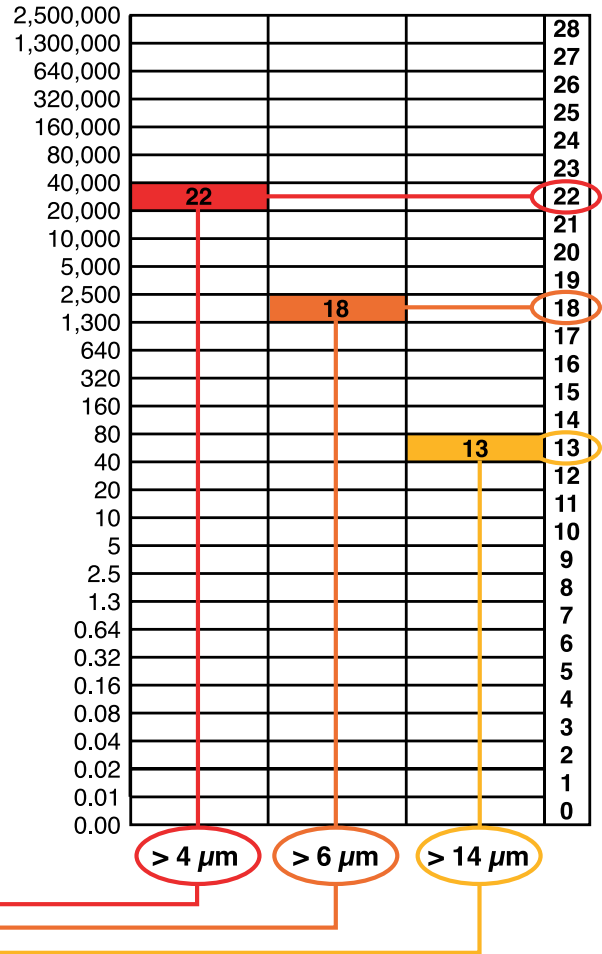

### Achieving the appropriate cleanliness level in a system

The only way to achieve and maintain the appropriate cleanliness level in a hydraulic or lubrication system, is to implement a comprehensive filtration program. HYDAC offers all of the products that are needed to monitor and control component and system cleanliness—they include:

#### Solid Contamination

- pressure filters
- return line filters
- offline filtration loops
- oil transfer units for precleaning new oil
- portable and online contamination monitors
- reservoir breathers and filler/breathers

#### Water Content

- water content sensors
- reservoir breathers with silica gel desiccant
- vacuum dehydration water removal units
- water removal elements

#### Fluid Analysis

- bottle sampling kits
- complete analysis kits

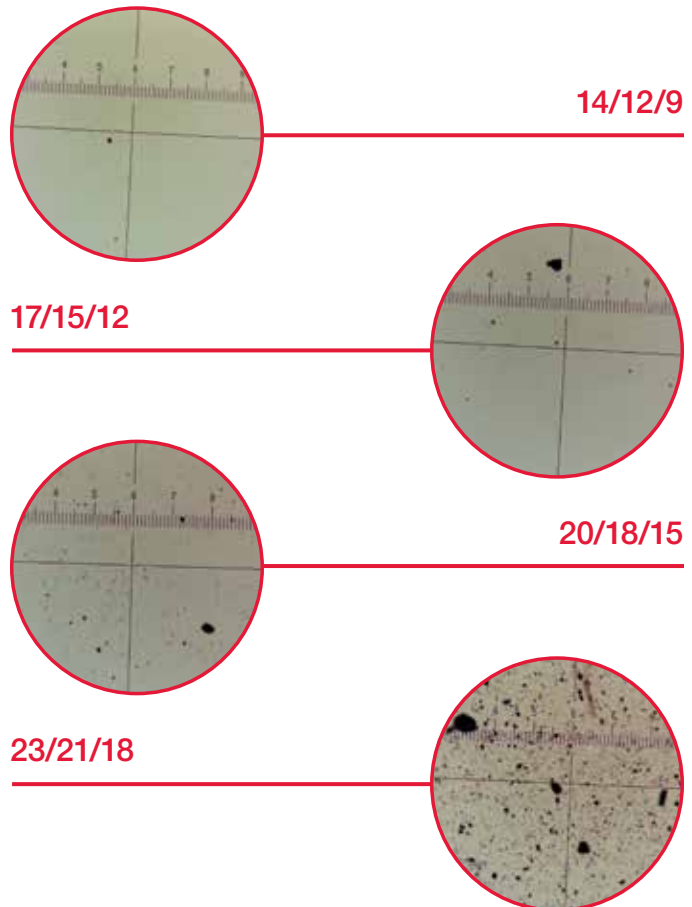

## Cleanliness Levels - ISO 4406 vs. ISO 4406:1999

The following example shown in Figures 4(a) and 4(b) compares the cleanliness level, or ISO rating, of a typical petroleum-based fluid sample using both the previous ISO Code 4406 and the current ISO Code 4406:1999 rating systems.

The fluid sample contains a certain amount of solid particle contaminants, in various shapes and sizes. Figure 4(a) shows a 100 mL sample that contains 300,000 particles greater than 2 µm in size, 20,000 particles greater than 5 µm in size, and 1,500 particles greater than 15 µm in size.

Since the particle count for contaminants size 2 µm and greater falls between 250,000 and 500,000, the first (optional) ISO range (or scale) number is 19 using Table 3(a). The particle count falls between 16,000 and 32,000 for particles greater than 5 µm, so the second ISO range number is 15. The particle count falls between 1,000 and 2,000 for particles greater than 15 µm, so the third ISO range number is 11. Thus, the cleanliness level for the fluid sample shown in Figure 4(a) per ISO 4406 is ISO 19/15/11.

In Figure 4(b), note that 1 mL of fluid (not per 100 mL) is measured per ISO 4406:1999. Also, the amount of particles at the 4 µm(c)/6 µm(c)/14 µm(c) levels are measured instead of at the 2 µm/5 µm/15 µm levels.

The number of 4 µm(c) particles falls between 2500 and 5000, so the first ISO range number is 19 using Table 3(b). The count for 6 µm(c) particles falls between 160 and 320 particles, so the second ISO range number is 15. The 14 µm(c) particle counts falls between 10 and 20, so the third range number is 11. Therefore, the cleanliness level for the fluid sample shown in Figure 4(b) per ISO 4406:1999 is 19/15/11.

Although the ranges for the scale numbers have changed, the resulting ISO Code has not changed.

Figure 4(a). Determining the ISO Rating of a Fluid Using ISO 4406 Previous

Sample Fluid 100 mL

Particle Size	Number of Particles	If Particle Count Falls Between	Scale Number is*
≥ 2 µm	300,000	250,000-500,000	19
≥ 5 µm	20,000	16,000-32,000	15
≥ 10 µm	4,000	1,000-2,000	11
≥ 15 µm	1,500		
≥ 20 µm	1,000		
≥ 30 µm	0.3		

\*Source: ISO/DIS 4406  
The Sample Fluid is ISO 19/15/11.

↑ optional

Figure 4(b). Determining the ISO Rating of a Fluid Using ISO 4406:1999 Current 1999

Sample Fluid 1 mL

Particle Size	Number of Particles	If Particle Count Falls Between	Scale Number is*
≥ 4 µm(c)	3,000	2,500-5,000	19
≥ 5 µm(c)	700	160-320	15
≥ 6 µm(c)	200	10-20	11
≥ 10 µm(c)			
≥ 14 µm(c)	15		
≥ 15 µm(c)			
≥ 20 µm(c)	10		
≥ 30 µm(c)	3		

\*Source: ISO 4406:1999  
The Sample Fluid is ISO 19/15/11.

## Required Cleanliness Levels

The pressure of a hydraulic system provides the starting point for determining the cleanliness level required for efficient operation. Table 4 provides general guidelines for recommended cleanliness levels based on pressure.

- Low pressure: 0-500 psi (35 bar)
- Medium pressure: 500-1500 psi (35-100 bar)
- High pressure: 1500 psi (100 bar) and above

Table 4. Cleanliness Level Guidelines Based on Pressure

System Type	Recommended Cleanliness Levels (ISO Code)
Low pressure – manual control	20/18/15 or better
Low to medium pressure – electro-hydraulic controls	19/17/14 or better
High pressure – servo controlled	16/14/11 or better

A second consideration is the type of components present in the hydraulic system. The amount of contamination that any given component can tolerate is a function of many factors, such as clearance between moving parts, frequency and speed of operation, operating pressure, and materials of construction. Tolerances for contamination range from that of low pressure gear pumps, which normally will give satisfactory performance with cleanliness levels typically found in new fluid (ISO 19/17/14), to the more stringent requirements for servo-control valves, which need oil that is eight times cleaner (ISO 16/14/11).

For your convenience, Table 5 provides a cross reference showing the approximate correlation between several different scales or levels used in the marketplace to quantify contamination. The table shows the code levels used for National Aerospace Standard (NAS)1638 and Military Standard 1246A, as well as the new SAE AS4059 standard.

Table 5. ISO Cleanliness Level Correlation

ISO Code 4 µm(c)/6 µm(c)/14 µm(c)	NAS 1638 (1967)	Mil Std. 1246A (1967)	ACFTD Gravimetric Level-mg/L	SAE AS4059 Standard
21/19/16	10			11
20/18/15	9			10
19/17/14	8	300		9
18/16/13	7		1	8
17/15/12	6			7
16/14/12		200		
16/14/11	5			6
15/13/10	4		0.1	5
14/12/9	3			4
13/11/8	2			3
12/10/8		100		
11/10/7	1			2

## Finding the cleanliness level required by a system

Today, many fluid power component manufacturers are providing cleanliness level (*ISO code*) recommendations for their components. They are often listed in the manufacturer's component product catalog or can be obtained by contacting the manufacturer directly. Their recommendations may be expressed in desired filter element ratings or in system cleanliness levels (*ISO codes or other codes*). Some typically recommended cleanliness levels for components are provided in table below.

1. Starting at the left hand column, select the most sensitive component used in the system.
2. Move to the right to the column that describes the system pressure and conditions.
3. Here you will find the recommended ISO class level, and recommended element micron rating.

**Table 6. Cleanliness Level Required by a System**

	Low/Medium Pressure Under 2000 psi (moderate conditions)		High Pressure 2000 to 2999 psi (low/medium with severe conditions <sup>1</sup> )		Very High Pressure 3000 psi and over (high pressure with severe conditions <sup>1</sup> )	
	ISO Target Levels	Micron Ratings	ISO Target Levels	Micron Ratings	ISO Target Levels	Micron Ratings
<b>Pumps</b>						
Fixed Gear or Fixed Vane	20/18/15	20	19/17/14	10	18/16/13	5
Fixed Piston	19/17/14	10	18/16/13	5	17/15/12	3
Variable Vane	18/16/13	5	17/15/12	3	not applicable	not applicable
Variable Piston	18/16/13	5	17/15/12	3	16/14/11	3 <sup>2</sup>
<b>Valves</b>						
Check Valve	20/18/15	20	20/18/15	20	19/17/14	10
Directional (solenoid)	20/18/15	20	19/17/14	10	18/16/13	5
Standard Flow Control	20/18/15	20	19/17/14	10	18/16/13	5
Cartridge Valve	19/17/14	10	18/16/13	5	17/15/12	3
Proportional Valve	17/15/12	3	17/15/12	3	16/14/11	3 <sup>2</sup>
Servo Valve	16/14/11	3 <sup>2</sup>	16/14/11	3 <sup>2</sup>	15/13/10	3 <sup>2</sup>
<b>Actuators</b>						
Cylinders, Vane Motors, Gear Motors	20/18/15	20	19/17/14	10	18/16/13	5
Piston Motors, Swash Plate Motors	19/17/14	10	18/16/13	5	17/15/12	3
Hydrostatic Drives	16/15/12	3	16/14/11	3 <sup>2</sup>	15/13/10	3 <sup>2</sup>
Test Stands	15/13/10	3 <sup>2</sup>	15/13/10	3 <sup>2</sup>	15/13/10	3 <sup>2</sup>
<b>Bearings</b>						
Journal Bearings	17/15/12	3	not applicable	not applicable	not applicable	not applicable
Industrial Gearboxes	17/15/12	3	not applicable	not applicable	not applicable	not applicable
Ball Bearings	15/13/10	3 <sup>2</sup>	not applicable	not applicable	not applicable	not applicable
Roller Bearings	16/14/11	3 <sup>2</sup>	not applicable	not applicable	not applicable	not applicable

1. Severe conditions may include high flow surges, pressure spikes, frequent cold starts, extremely heavy duty use, or the presence of water
2. Two or more system filters of the recommended rating may be required to achieve and maintain the desired Target Cleanliness Level.

# Section 2: Element Technical Data

## Performance Specifications / Filtration Rating

HYDAC filter elements meet a wide variety of requirements in today's workplace, from the simplest to the most sophisticated fluid power systems. Established industry standards enable users to select the optimal filter element for any application.

Filter elements are rated on the basis of their ability to remove contaminants of specific targeted sizes from a fluid, under specific operating conditions. Filtration ratings can be measured by analyzing three areas of performance:

- (1) efficiency or filter element Beta rating and resulting percent efficiency,
- (2) dirt holding capacity (DHC), and
- (3) the pressure drop across the element over a range of flow conditions (PQ).

## The Multi-Pass Test

Filter element efficiency ratings and capacities are determined by conducting a multi-pass test under controlled laboratory conditions. This is a standard industry test with procedure published by the International Standards Organization (ISO), the American National Standards Institute (ANSI), and the National Fluid Power Association (NFPA). The multi-pass test yields reproducible test data for appraising the filtration performance of a filter element including its particle removal efficiency under ideal conditions. These test results enable the user to: (1) compare the Beta efficiency, dirt holding capacity, and Beta stability characteristics of elements offered by various filter element suppliers and (2) helps one to select the proper filter element when also evaluating the structural integrity and pleat support system designed to obtain the optimal contamination control level for any particular system under dynamic operating conditions.

Hydraulic fluid (*Mil. Spec. 5606*) is circulated through a system containing the filter element to be tested. Additional fluid contaminated with ISO MTD Test Dust is introduced upstream of the element being tested. The fluid is monitored upstream and downstream of the test element to determine the element contamination removal efficiency.

$$\beta_{x(c)} = \frac{\text{number of particles upstream}}{\text{number of particles downstream}}$$

Dirt holding capacity is defined as the total grams of ISO MTD Test Dust added to the system to bring the test filter element to terminal pressure drop. (*Alarm Trip Point*)

## Filtration Ratio (Beta) ISO 4572 vs. ISO 16889

Due to the changes in the way particles are measured and the fact that a new test dust (ISO MTD) is now utilized, a new standard for multi-pass testing was necessary. This now current standard, ISO 16889, replaces the old Multi-Pass Test Standard, ISO 4572.

The filtration ratio (*more commonly referred to as the Beta ratio*) is, in fact, a measure of the particle capture efficiency of a filter element.

### ISO 4572 (Old)

$$\beta_x = \frac{\text{number of particles upstream } \geq x \text{ microns}}{\text{number of particles downstream } \geq x \text{ microns}}$$

where x is a specified particle size (*in microns*).

### ISO 16889 (Current 1999)

$$\beta_{x(c)} = \frac{\text{number of particles upstream } \geq x(c) \text{ microns}}{\text{number of particles downstream } \geq x(c) \text{ microns}}$$

where x(c) is a specified particle size (*in microns*).

Example:  $\beta_{10(c)} = \frac{7500}{100} = 75$

This particle capture efficiency can also be expressed as a percent by subtracting the number 1 from the Beta value, dividing by Beta value and multiplying the result by 100:

$$\text{Beta}_{10(c)} \text{ efficiency} = 75 = \frac{(\beta - 1)}{\beta} \times 100$$

$$\text{Beta}_{10(c)} \text{ efficiency} = \frac{(75 - 1)}{75} \times 100 = 98.667\%$$

The example is read as "Beta ten is equal to 75, where 7500 particles, 10 microns and larger, were counted upstream of the test filter (*before*) and 100 particles, 10 microns and larger, were counted downstream of the test filter (*after*)."

The filter element tested was 98.667% efficient in removing particles 10 microns and larger.

Figure 5. Multi-Pass Test Schematic

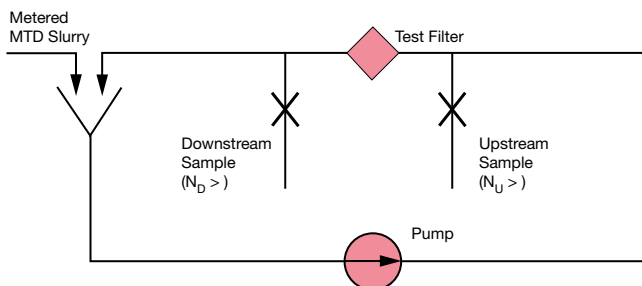

# OVERVIEW

## Percent Efficiency

To calculate a filter element's percent efficiency, subtract 1 from the Beta, divide that answer by the Beta, then multiply by 100.

**Table 7. Filter Element Percent Efficiency**

Example Per ISO 4572 (old):	Example Per ISO 16889 (new):
Step 1: $\beta_{10} \geq 75$	$\beta_{10(c)} \geq 75$
Step 2: $75 - 1 = 74$	$75 - 1 = 74$
Step 3: $74 \div 75 = 0.987$	$74 \div 75 = 0.987$
Step 4: $0.987 \times 100 = 98.7\%$	$0.987 \times 100 = 98.7\%$

Using a calculator with a % key, you can use the shortcut version.

Example Per ISO 4572 (old):	Example Per ISO 16889 (new):
Step 1: $\beta_{10} \geq 200$	$\beta_{10(c)} \geq 200$
Step 2: $200 - 1 = 199$	$200 - 1 = 199$
Step 3: $199 \div 200 = 99.5\%$	$199 \div 200 = 99.5\%$

## Filter Beta Rating

ISO 16889 replaces ISO 4572 as the International Standard for Multi-pass Testing. It provides a common testing format for filter manufacturers to rate filter element performance. For convenience, Betas are shown in this catalog for both old and new Multi-pass standards (*ISO 4572 and 16889, respectively.*)

According to ISO 16889, each filter manufacturer can test a given filter element at a variety of flow rates and terminal pressure drop ratings that fit the application, system configuration and filter element size. Results may vary depending on the configuration of the filter element tested and the test conditions.

Currently, there is no accepted ISO, ANSI, or NFPA standard regarding "absolute" ratings. Filter manufacturers have generally adopted an industry standard using  $\beta_{x(c)} \geq 75$  (98.7% efficiency) as a minimum efficiency to rate an element as a high efficiency depth filter media. Filter manufacturers generally rate their high efficiency elements as  $\beta_{x(c)} \geq 100$  (99.0% efficiency),  $\beta_{x(c)} \geq 200$  (99.5% efficiency), or  $\beta_{x(c)} \geq 1000$  (99.9% efficiency). Performance of HYDAC elements is typically a minimum rating of  $\beta_{x(c)} \geq 1000$ , with high dirt holding capacities and lower pressure drops in optimum balance to meet the dynamics and stresses of all applications.

## Dirt Holding Capacity

Dirt holding capacity (DHC) is the amount of contaminant (*expressed in grams*) the element will retain before it goes into alarm (*terminal pressure*). All other factors being equal, an element's DHC can provide indication of how long the element will last until full. This characteristic, taken into context with a structural and pleat support evaluation will provide good indication of what element should last longer in system operation.

Dirt holding capacity, sometimes called "apparent capacity," is a very important and often overlooked factor in selecting the right element for the application. The dirt holding capacity of an element is measured in grams of ISO medium test dust contaminant as determined from the multi-pass test (*ISO 16889*), and measured at the terminal  $\Delta P$  (*alarm point*). When selecting filter elements, it is beneficial to compare the dirt holding capacities of elements with similar particle removal efficiencies and good structural and pleat support characteristics.

## Pressure Drop

When sizing a filter, it is important to consider the initial differential pressure ( $\Delta P$ ) across the element and the housing. Elements offering a lower pressure drop at a high Beta efficiency are better than elements with a high  $\Delta P$  at the same efficiency. At every level of filtration, HYDAC Betamicon® media elements offer a superior combination of high efficiency, high dirt holding capacity, and low pressure drop with the media support design that provides the highest levels of performance under dynamic fluid conditions.

## Collapse Rating

The collapse rating of a filter (*determined by ISO 2941/ANSI B93.25*) represents the differential pressure across the element that causes the media to fail. The collapse rating of an element should be on the order of 3 times higher than the filter bypass setting. The collapse rating for filter elements used in filter housings with no bypass valve should be at least the same as the setting of the system relief valve upstream of the high collapse element. When a collapsed element becomes clogged with contamination all functions downstream of the filter will become inoperative due to the release of high levels of contamination to the critical hydraulic components - **Loss of Protection.**



# Element Selection

## The Right Media for the Right Application = Job Matched Filtration

### Filtration Application Guidelines

Selecting the proper HYDAC media for your application is easy if you follow these simple guidelines.

- Step 1.** Remember that the key to cost effective contamination control is to maintain the system's cleanliness at the tolerance level of the system's most sensitive component. So, the first step is to identify the most sensitive component.
- Step 2.** Determine the desired cleanliness level (ISO Code) for that component by referring to Table 5 (*in this Overview*) by reference to the customer's component manuals or by contacting the component manufacturer directly.
- Step 3.** Referring to Table 8 identify the HYDAC filter medium that will meet or exceed the desired cleanliness level.
- Step 4.** Remember to regularly check the effectiveness of the selected media through the use of contamination monitoring tools and equipment.

**Table 8. HYDAC Element Media Recommendations**  
Oil cleanliness to ISO 4406  
Filtration rating  $\times (\beta_{x(c)} \geq 200)$

Desired Cleanliness Levels (ISO Code 4406)	HYDAC Media
19/16/13 to 22/19/16	25 $\mu\text{m}$
18/15/12 to 21/18/15	20 $\mu\text{m}$
17/14/11 to 20/17/14	15 $\mu\text{m}$
15/12/9 to 19/16/13	10 $\mu\text{m}$
12/9/6 to 17/14/11	5 $\mu\text{m}$
10/7/4 to 13/10/7	3 $\mu\text{m}$

### Effect of Dirt Ingression

Filter element life varies with the true dirt holding capacity of the element under dynamic flow conditions and the amount of dirt introduced into the circuit. The rate of this dirt ingress in combination with the desired cleanliness level should be considered when selecting the media to be used for a particular application.

The amount of dirt introduced can vary from day to day and hour to hour, generally making it difficult to predict when an element will become fully loaded. This is why we recommend specifying a filter indicator.

Filter indicators provide a vital measure of protection for your system by indicating when the filter element needs to be changed or cleaned. HYDAC filters are available with visual, electrical and electrical-visual combination filter indicators. These indicators may also be purchased as separate items.

### Amount of Fluid Filtered

To obtain the desired cleanliness level (ISO Code) using the suggested HYDAC filter medium, it is recommended that a minimum of one-third of the total fluid volume in the system pass through the filter per minute. If fluid is filtered at a higher flow rate, better results may be achieved. If only a lesser flow rate can be filtered, a more efficient media may be required.

Systems operating in a clean environment, with efficient air-breather filters and effective cylinder rod wiper seals, may achieve the desired results at a lower turnover rate. Systems operating in a severe environment or under minimal maintenance conditions should have a higher turnover. Turnover must be considered when selecting the location of the system's filter(s).

### Sizing a Filter Element

Since the pressure drop versus flow data contained in our filter catalog is for fluids with a viscosity of 141 SUS (30 cSt), and a specific gravity of 0.86, we are often asked how to size a filter with a viscosity other than 141 SUS (30 cSt) or a specific gravity other than 0.86. In those instances where the viscosity or specific gravity is significantly higher, it may be necessary to use a larger element. To make this determination, we need to calculate the life of the element, using the following equation:

$$EL = IA - (H + E)$$

Where:

EL	=	Element Life (expressed in psi)
H	=	Housing pressure drop
IA	=	Indicator Alarm trip point
E	=	Element pressure drop

1. The housing pressure drop can be read directly from a graph. This value is not significantly affected by viscosity or the number of elements in the housing, since housing flow is turbulent.
2. The element pressure drop is directly proportional to viscosity, influenced by high pressure since element flow is laminar.

A "rule of thumb" for element life, as calculated from the above equation, is to work towards a filter assembly differential pressure drop that is typically no greater than 20% of alarm trip setting.

**Table 9. Typical Pressure Drop Maximum Targets for Filter sizing:**

Max. Pressure Drop	Type
10 – 15 psid	Pressure Filters
4 – 8 psid	Return Filters
2 – 6 psid	Lube Systems

Filter assembly differential pressure should never exceed 50% alarm trip point even in most demanding applications.

The interval between element change-outs can be extended by increasing the total filter element area. Many HYDAC filters can be furnished with one, two, or three elements or with larger elements. By selecting a filter with additional element area, the time between servicing can be extended for minimal additional cost.

# OVERVIEW

## Fluid Compatibility: Fire Resistant Fluids

HYDAC filters have been used successfully to filter a variety of fire resistant fluids. Filtering these fluids requires careful attention to filter selection and application. Your fluid supplier should be the final source of information when using these fluids. The supplier should be consulted for recommendations regarding limits of operating conditions, material and seal compatibility, and other requirements peculiar to the fluid being used within the conditions specified by the fluid supplier.

## High Water Content Fluids

High water base fluids consist primarily of two types: water and soluble mineral base oil, and water with soluble synthetic oil. The oil proportion is usually 5%, but may vary from as low as 2% to as high as 10%.

Standard HYDAC US manufactured Betamicon® elements are compatible with both (HFA & HFC) types of high water content fluids. Filter sizing is accomplished the same as it is done with other mineral based hydraulic fluids. Some special factors that need to be considered in the selection process include the following:

- All aluminum in the filter housing should be high water based tolerant or anodized.
- Buna N or Viton seals are recommended, subject to manufacturer stated compatibility.
- The high specific gravity and low vapor pressure of these fluids create a potential for severe cavitation problems. Suction filters or strainers should not be used with these fluids.

## Invert Emulsions

Invert emulsions consist of a mixture of petroleum based oil and water. Typical proportions are 60% oil to 40% water. Standard HYDAC filters with 10 µm and 25 µm media elements are satisfactory for use with these fluids. Filters should be sized conservatively for invert emulsions. These fluids are non-Newtonian - their viscosity is a function of shear. We recommend up to twice the normal element area be used as space and other conditions permit.

Some special factors that need to be considered in the selection process include the following:

- Potential exists for cavitation problems with invert emulsions similar to high water based fluids.
- Buna N or Viton seals are recommended, subject to manufacturer stated compatibility.

## Water Glycols

Water glycols consist of a mixture of water, glycol, and various additives. HYDAC Betamicon® filter elements are compatible for use with these fluids. Some special factors that need to be considered in the selection process include the following:

- All aluminum in the filter should be water tolerant or anodized.
- Potential exists for cavitation problems with water glycols similar to high water based fluids.
- Buna N or Viton seals are recommended, subject to manufacturer stated compatibility.

## Phosphate Esters

Phosphate esters are classified as synthetic fluids. All HYDAC filters and elements can be used with most of these fluids. Sizing should be the same as with mineral based oils of similar viscosity. Some special factors that need to be considered in the selection process include the following:

- Use any Betamicon® media with EPR or Viton seals if required by fluid manufacturer for phosphate esters.
- Use S0103H (*low collapse*) or S0155H (*high collapse*).

## Pressure Drop Correction for Specific Gravity (filter housing)

Filter housing pressure drop curves shown in this catalog are predicated on the use of petroleum based fluid with a specific gravity of 0.860. The various fire resistant fluids discussed in this section have a specific gravity higher than 0.860, which affects pressure drop. Use the following formula to compute the correct pressure drop for the higher specific gravity:

Corrected pressure drop =

$$\frac{\text{Fluid specific gravity}}{0.860} \times \text{Catalog pressure drop}$$

# Section 3: Filter Selection Considerations

## Filter Location

**Pressure filtration:** Pressure filters usually produce the lowest system contamination levels to assure clean fluid for sensitive high-pressure components and provide protection of downstream components in the event of catastrophic failures. Systems with high intermittent return line flows may need only be sized to match the output of the pump, where the return line may require a much larger filter for the higher intermittent flows. See Figure 6(a).

**Return line filtration:** Return line filters are often considered when initial cost is a major concern. A special concern in applying return line filters is sizing for flow. Large rod cylinders and other components can cause return line flows to be much greater than pump output. Return lines can have substantial pressure surges, which need to be taken into consideration when selecting filters and their locations. See Figure 6(b).

**Re-circulating (kidney loop) filtration:** While usually not utilized as a system's primary filtration, re-circulating, or off-line, filtration is often used to supplement in-line filters when adequate turnover cannot be obtained with the inline filter. It is also often an ideal location in which to use a water removal filter. See Figure 6(c).

**Suction filtration:** High efficiency suction filters are not recommended for open-loop circuits. The cavitation these filters can cause far outweighs any advantage obtained by attempting to clean the fluid in this part of the system.

**Breather filtration:** Efficient filter breathers are required for effective contamination control on nonpressurized reservoirs and should complement the liquid filtration component.

**Multiple filtration:** For systems incorporating large total fluid volumes, it may be necessary to employ filters in more than one location. Multiple pressure filters, pressure and return line filters, and recirculating filters are examples of multiple filtration applications.

Figure 6(a). Pressure Filtration Circuit

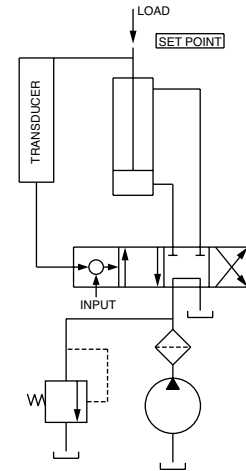

Figure 6(b). Return Line Filtration Circuit

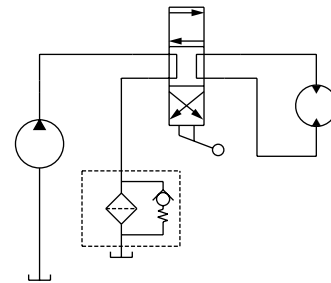

Figure 6(c). Re-circulating Filtration Circuit

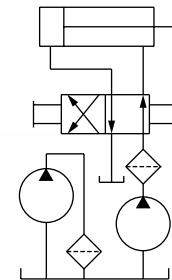
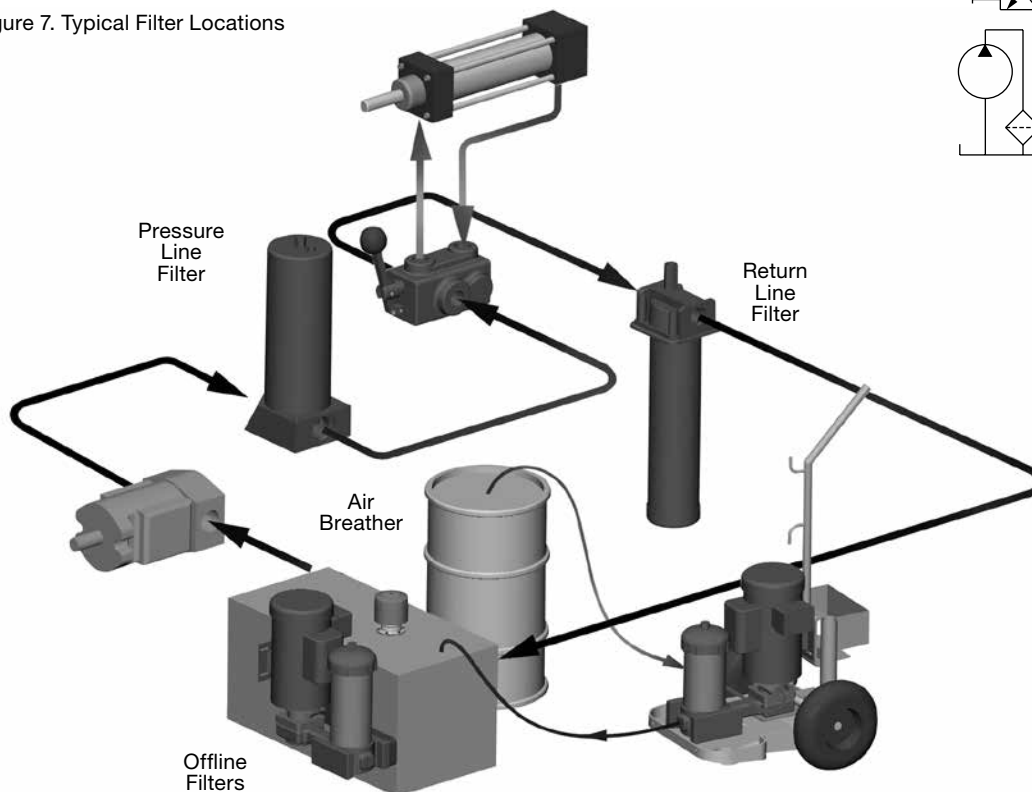

Figure 7. Typical Filter Locations



# OVERVIEW

## Seven Steps to Selecting a Filter

It is important to keep in mind that all system components have some tolerance for contamination. The key to cost effective contamination control is to maintain the system's cleanliness level at the tolerance level of the most sensitive component. Once the desired cleanliness level (ISO code) is determined, designing and selecting a cost effective filtration system can be readily accomplished.

- 1. Determining desired cleanliness level** Step 1. Determine the most sensitive component in the system. Then, determine the desired cleanliness level (*ISO code*) by using Tables 4 and 5 (*in this Overview*), review of component manuals or by contacting the component manufacturer directly.  
  
Operating pressure levels and system environmental conditions also have a bearing on cleanliness requirements.
- 2. Selecting correct medium** Step 2. Using Table 9 (*in this Overview, respectively*), identify the proper HYDAC filter media rating to employ.
- 3. Where to filter** Step 3. Determine where to locate the filters, using the information on "Filter Location" (*Section 3, in this Overview*).
- 4. Selecting filter housing** Step 4. Refer to Filter Products in the Table of Contents or the Quick Reference Guide and the individual filter catalog pages to select the specific filter housing that will meet the requirements set forth in Steps 2 and 3 above, as well as the pressure and flow parameters where the particular filter will be located.  
  
Consideration should also be given to installation convenience for your particular application. Use the filter selection charts shown on the catalog pages to determine the specific filter model number for the desired media rating at the required flow rate.
- 5. Selecting filter breather** Step 5. For nonpressurized reservoirs, refer to the HYDAC Accessories Catalog to select the appropriate filter breather.
- 6. Contamination control practices** Step 6. Implement the appropriate manufacturing, assembly, and maintenance contamination control procedures. Effective contamination control is achieved through the conscientious use of sound manufacturing and maintenance practices. Some examples are: filtering make-up oil; controlling contamination ingestion during manufacturing, assembly, maintenance, and repair processes; and properly maintaining cylinder wiper seals.
- 7. Verifying results** Step 7. Check all filtration systems to determine if the results expected are obtained and maintained during system operation, as operating conditions and maintenance practices may not remain constant. Take periodic fluid samples on a regular basis to monitor cleanliness, water content and variations on amounts of wear metals. HYDAC distributors and field representatives have access to contamination monitoring equipment that can determine the exact cleanliness level (*ISO code*) of your system on the spot. Contact your HYDAC distributor or phone us for complete details.

## Rated Fatigue Pressure

The application of individual filters should take fatigue ratings into consideration when there are flow or pressure variations creating pressure peaks and shock loads.

Typical hydraulic systems that use highly repetitive operations include plastic injection molding machines, die-cast machines, and forging and stamping press systems. In these and other similar applications, rated fatigue pressure should be considered when selecting a filter.

The National Fluid Power Association has introduced a method (*NFPA T2.6.1*) for verifying the fatigue pressure rating of the pressure-containing envelope of a metal fluid power component. In this method, components are cycled from 0 to test pressure for 1 million cycles (*10 million cycles is optional*). The rated fatigue pressure (*RFP*) is verified by testing. We establish the desired RFP from design, then we calculate the cycle testing pressure (*CTP*), and then conduct tests at CTP per 1,000,000 cycles.

The T2.6.1 Pressure Rating document is available from the National Fluid Power Association, 3333 N. Mayfair Road, Milwaukee, WI 53222-3219.

The NFPA has established that the maximum allowable Work Pressure is equal to the Rated Fatigue Pressure (*RFP*).

# Sizing HYDAC Filter Assemblies

To properly size and calculate the pressure drop across a filter for a particular application the following procedures should be strictly followed:

Assembly pressure drop ( $\Delta P$ ) is the sum of the  $\Delta P$  across the filter housing plus the  $\Delta P$  across the filter element.

This simple formula is shown below:

$$\Delta P \text{ Filter Assembly} = \Delta P \text{ Housing} + \Delta P \text{ Clean Element}$$

To calculate a filter assembly  $\Delta P$  we must first know the specifics of the application.

To calculate the  $\Delta P$  across the housing we must know the flow rate and specific gravity of the fluid we wish to filter. A chart is provided in each of the product pages that provides a curve outlining the pressure drop across the housing based upon the flow in GPM (*gallons per minute*). This data must then be adjusted if the specific gravity is at a lower or higher point than the test Hydraulic Fluid (0.86). The formula for calculation of the housing  $\Delta P$  is shown as follows:

$$\Delta P \text{ Housing} = \Delta P \text{ (From Curve in catalog)} \times \frac{\text{Actual Specific Gravity}}{0.86}$$

To calculate the  $\Delta P$  across the element additional information is required. This will include the **viscosity** of the fluid (*at operating temperature*), required **filtration rating in  $\mu\text{m}$**  (*microns*), **type of element** (*High collapse -BH or Low collapse -BN*), and **K** (*coefficient*) factor from the attached conversion tables. With this information the following formula is used to calculate  $\Delta P$  across the element. Again the specific gravity and viscosity (*standard hydraulic fluid figured at a viscosity of 141 SSU - Saybolt Universal Seconds - 30 centistokes*) will change the  $\Delta P$ .

$$\Delta P \text{ Clean Element} = \frac{\text{Flow Rate GPM} \times \text{Element K factor}}{\text{or } (\Delta P \text{ from element curve})} \times \frac{\text{Actual Specific Gravity}}{0.86} \times \frac{\text{Actual Viscosity in SSU}}{141}$$

**EXAMPLE** - an application with the following criteria would be sized as shown.

<b>Conditions:</b>	<b>Fluid</b> – Hydraulic Oil (ISO-32)	<b>Flow Rate</b> – 30 GPM
	<b>Specific Gravity</b> – 0.86	<b>Max. Operating Pressure</b> – 4,500 psi
	<b>Viscosity</b> – 141 SSU	<b>Normal Operating Pressure</b> – 4,000 psi
	<b>Micron Rating</b> – 10 $\mu\text{m}$	<b>Bypass</b> - YES ( <i>Low collapse element</i> )
	<b>Fluid Temperature</b> - 104°F normal	<b>Viscosity</b> = 141 SUS @ 104°F

**Filter Type Selected - Pressure Filter**

**HYDAC Model No. DF ON 240 TE 10 D 1.0 / 12 V -B6**

## HOUSING

$$\Delta P \text{ Housing} = \Delta P \text{ Calculation (From Curve in catalog)} \times \frac{\text{Actual Specific Gravity}}{0.86}$$

$$\Delta P \text{ Housing} = 1.5 \text{ psid} \times \frac{0.86}{0.86} = 1.5 \text{ psid}$$

## ELEMENT

$$\Delta P \text{ Clean Element} = \Delta P \text{ Calculation} \times \frac{\text{Actual Specific Gravity}}{0.86} \times \frac{\text{Actual Viscosity}}{141 \text{ SSU}}$$

$$\Delta P \text{ Clean Element} = 30 \text{ GPM} \times 0.175 \times \frac{0.86}{0.86} \times \frac{141 \text{ SSU}}{141 \text{ SSU}}$$

$$\Delta P \text{ Clean Element} = 5.25 \times 1 \times 1 = 5.25 \text{ psid}$$

## FILTER ASSEMBLY

$$\Delta P \text{ Filter Assembly} = \Delta P \text{ Housing} + \Delta P \text{ Clean Element} \quad \left. \begin{array}{l} 1.5 \text{ psid} + 5.25 \text{ psid} = 6.75 \text{ psid} \end{array} \right\} \text{Clean assembly } \Delta P \text{ is less than 10 – 15 psid per "Typical Targets" on Table 9 (in this Overview)}$$

NOTE:

**A change in the fluid can make a significant difference in the pressure drop across a filter assembly. A second calculation for the element ( $\Delta P$ ) should be done at the lowest temperature condition (cold start) to determine how the filter will operate under these severe conditions with significantly higher viscosity.**

See the next page for Cold Start Calculation.

# OVERVIEW

**EXAMPLE** - an application with the following criteria would be sized as shown. *(Cold Start Condition)*

<b>Conditions:</b>	<b>Fluid</b> – Hydraulic Oil (ISO 32)	<b>Flow Rate</b> – 30 GPM
	<b>Specific Gravity</b> – 0.86	<b>Max. Operating Pressure</b> – 4,500 psi
	<b>Viscosity</b> – 400 SSU	<b>Normal Operating Pressure</b> – 4,000 psi
	<b>Micron Rating</b> - 10µm	<b>Bypass</b> - YES <i>(Low collapse element)</i>
	<b>Fluid Temperature</b> - 32°F cold	<b>Viscosity @ Cold Start</b> = 1350 SUS @32°F

## Filter Type Selected

HYDAC Model No. **DF ON 240 TE 10 D 1.0 / 12 V - B6**

## HOUSING

$\Delta P$  Housing =  $\Delta P$  Calculation *(From Curve in catalog)* x  $\frac{\text{Actual Specific Gravity}}{0.86}$

$$\Delta P \text{ Housing} = 1.5 \text{ psid} \times \frac{0.86}{0.86} \text{ or } (1.0) = 1.5 \text{ psid}$$

## ELEMENT

$\Delta P$  Clean Element =  $\Delta P$  Calculation x  $\frac{\text{Actual Specific Gravity}}{0.86}$  x  $\frac{\text{Actual Viscosity}}{141 \text{ SSU}}$

$$\Delta P \text{ Clean Element} = 30 \text{ GPM} \times 0.175 \times \frac{0.86}{0.86} \times \frac{1350 \text{ SSU}}{141 \text{ SSU}}$$

$$\Delta P \text{ Clean Element} = 5.25 \times 1.0 \times 9.6 = 50.40 \text{ psid}$$

## FILTER ASSEMBLY

$\Delta P$  Filter Assembly =  $\Delta P$  Housing +  $\Delta P$  Clean Element  
 $1.5 \text{ psid} + 50.40 \text{ psid} = 51.90 \text{ psid}$  *(Almost 8 times normal clean assembly  $\Delta P$ )*

### NOTE:

**When the element is partially loaded with some contamination and the system is cold started, the indicator may trip or possibly go into bypass, until the fluids in the system warm up. This information is relative and important for our customers to understand as they operate their systems under diverse conditions. This additional performance data helps our customers to define their system operating procedures, assist in component selection and finalize design.**

# Additional Filter Sizing Considerations for Industrial Machines by Flow Rate

## 1. Initial filter assembly clean differential pressure drop <20 - 30% of indicator trip pressure at average flow

**EXAMPLE** - DF 330: Indicator Trip Pressure is 72 psid  
 →max assembly pressure drop with clean element: 72 psid x 0.25 = 18 psid

## 2. Check pressure drop at maximum flow (especially when cylinders used)

If pressure drop at maximum flow is >50% of indicator trip pressure use one size larger.  
 Check again if pressure drop is now <50%.

## 3. Check behavior under cold start conditions

If you have a lot of cold starts or work with cold oil chose one size larger.

## 4. Make sure that the port size is large enough to handle the flow

Suction	Return Line	Pressure <1,500 psi	Pressure <4000 psi	Pressure <6000 psi
15 ft/sec	15 ft/sec	15 ft/sec	26 ft/sec	40 ft/sec

## 5. Always contact Product Management to double check

# Additional Filter Sizing Considerations for Mobile Machines by Flow Rate

## 1. Initial filter assembly clean differential pressure drop <20-30% of indicator trip pressure at average flow

**EXAMPLE** - RFM 270: Indicator Trip Pressure is 29 psi  
 →max assembly pressure drop with clean element: 29 psi x 0.25 = 7.25 psi

## 2. Check pressure drop at maximum flow (especially when cylinders are used)

If pressure drop at maximum flow is >50% of indicator trip pressure use one size larger.  
 Check again if pressure drop is now <50%.

## 3. Check behavior under cold start conditions

If you have a lot of cold starts or work with cold oil choose one size larger.

## 4. Make sure that the port size is large enough to handle the flow

Return Line	Pressure <1,500 psi	Pressure <4000 psi	Pressure <6000 psi
15 ft/sec	15 ft/sec	26 ft/sec	40 ft/sec

## 5. Always contact Product Management to double check

## Filter Applications Worksheet

\*Name: \_\_\_\_\_ \*Title: \_\_\_\_\_

\*Company: \_\_\_\_\_ \*Email: \_\_\_\_\_

\*Address: \_\_\_\_\_ State: \_\_\_\_\_ Zip: \_\_\_\_\_

\*Phone: \_\_\_\_\_ Mobile: \_\_\_\_\_ Fax: \_\_\_\_\_

<b>End User System Application</b>		
<b>*System Critical Components</b> <i>(i.e. Servo's, Proportional Valves)</i>		
<b>*Fluid Operating Temperature Range</b> From: _____ °F To: _____ °F		
<b>*Ingested Dirt Levels</b> <i>(check one)</i> <input type="radio"/> Heavy <input type="radio"/> Medium <input type="radio"/> Light		
<b>*Clean Filter Differential Pressure Limit</b> _____ psid <i>(typically 40%-50% Indicator trip setting)</i>		
<b>*ISO/NAS Cleanliness Target Level</b>		
<b>*Maximum Operating Pressure</b> _____ psi		
<b>*Nominal Operating Pressure</b> _____ psi		
<b>*Filter Flow Rate Nominal / Maximum</b> _____ gpm nominal _____ gpm maximum		
<b>*Hydraulic Fluid</b>		
Manufacturer	Type	
Designation		
Viscosity @ nominal	SUS	Cs
Viscosity @ cold start	SUS	Cs
Specific Gravity		

<b>*Special Operating Requirements</b> <i>(reverse flow, bidirectional flow duplex, or other special requirements)</i>
<b>Mounting Orientation &amp; Port Configuration</b> Inlet _____ Outlet _____
<b>Inlet/Outlet Configuration</b> <i>(i.e. inline, side inlet/bottom outlet)</i>
<b>Filter Changeout Access</b> <i>(i.e. top or bottom)</i>
<b>Bypass Requirements</b> <input type="radio"/> 87 <input type="radio"/> 43 <input type="radio"/> 25 <input type="radio"/> 15 <input type="radio"/> 3 (psid) <input type="radio"/> Non Bypass KB
<b>*Indicator Requirements</b> <i>(check one)</i> <input type="radio"/> B <input type="radio"/> BM <input type="radio"/> C <input type="radio"/> D <input type="radio"/> E/ES <input type="radio"/> F <input type="radio"/> G <input type="radio"/> GC <input type="radio"/> GW <input type="radio"/> H <input type="radio"/> J <input type="radio"/> J4 <input type="radio"/> K <input type="radio"/> LE <input type="radio"/> LZ <input type="radio"/> UE <input type="radio"/> UF <input type="radio"/> UG <input type="radio"/> V <input type="radio"/> Other
Supply Voltage (LED for D Indicators): <input type="radio"/> Diff. Pressure <input type="radio"/> Static <input type="radio"/> Vacuum Indication <i>(check one)</i>
<b>*Filtration Rating Requirements</b> Micron Rating _____ Depth / Surface _____ Element Media _____ ISO Cleanliness Target _____
<b>System Maintenance Comments</b> <i>(Sampling/changeout frequency, maintenance practices)</i>

\*Required Information to properly quote.



# B Overview of Elements

# FILTER ELEMENTS

## Overview of Elements

### Optimicon® Elements

- ON - code designation
- Glass fiber, multi-layered with support
- Collapse rating - 290 psid (20 bar)
- 1, 3, 5, 10, 15, 20 micron
- Filtration Rating  $\beta_{x(e)} \geq 1000$
- Depth Filtration
- Pressure and Return elements available
- Disposable - single use element
- Plastic outerwrap



### Element Construction

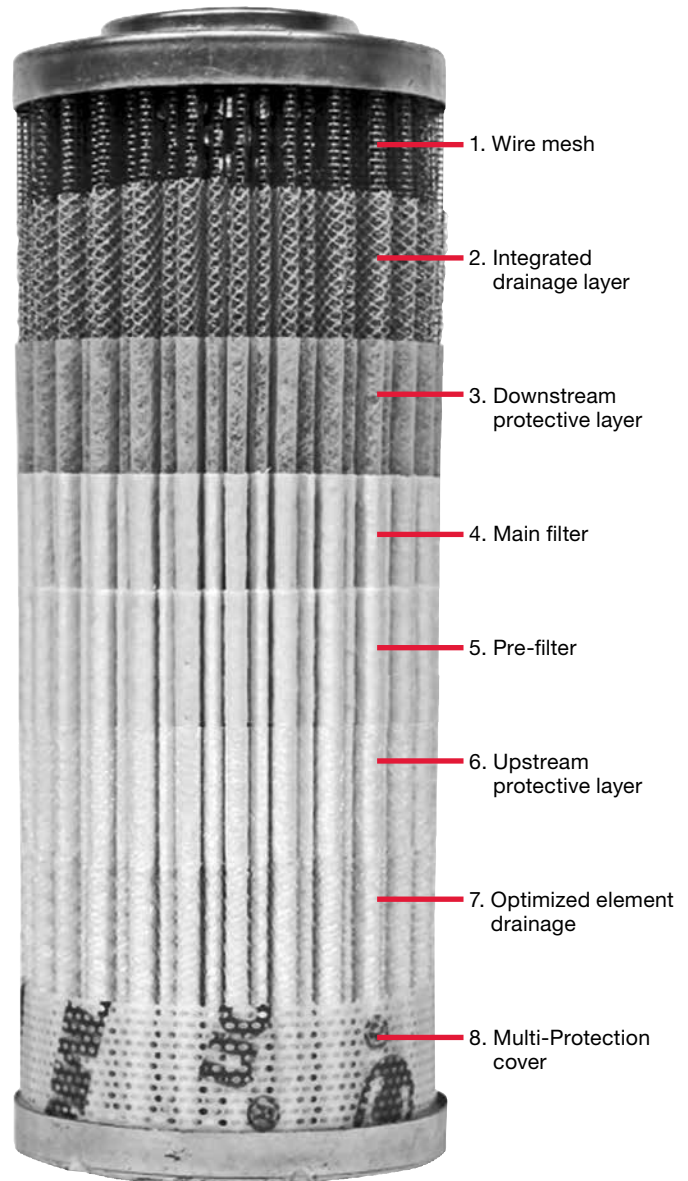

### Optimicon® Pressure Element

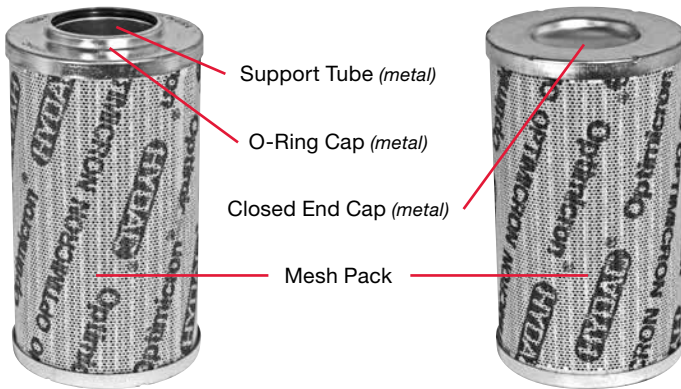

### Optimicon® Return Element

Return filters include Bypass in the endcap - insures proper bypass operation at all times.

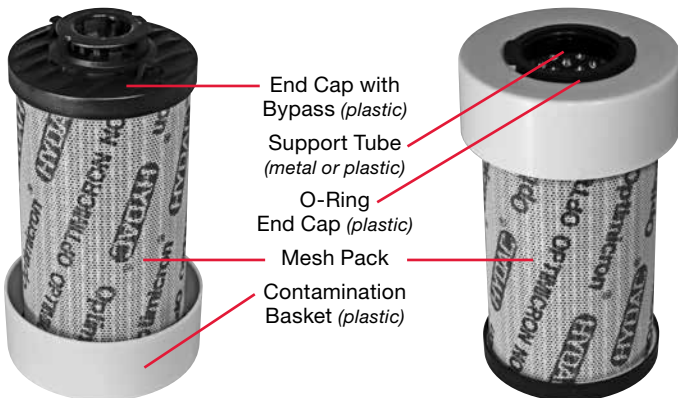

### Optimicon® Power Elements

- ON/PO - code designation
- Synthetic Fiber, multi-layered with support
- All Plastic Construction
- Collapse Rating - 145 psid
- 3, 5, 10, 20 micron
- Stat-Free Technology included
- Depth Filtration
- Disposable - single use element
- Plastic outerwrap
- API 614 Approved



## Betamicon® Elements

- BN4HC - Low Collapse (290 psid)
- BH4HC - High Collapse (3045 psid)
- Fiberglass, Non-Woven
- 1, 3, 5, 10, & 20 micron
- Filtration Rating  $\beta_{x(c)} \geq 1000$
- High Beta Stability
- Structurally Designed for Dynamic Flow Conditions
- Collapse Rating 290 psid
- Depth Filtration
- Disposable



## Betamicon® / Aquamicon® Combination Elements

- BN4AM - code designation
- Collapse Rating - 145 psid
- Undissolved (free) **Water Removal ONLY!**
- 3 & 10 micron
- Filtration Rating  $\beta_{x(c)} > 200$
- Depth Filtration
- Disposable



## ECOmicron® Elements

- ECON2 - code designation
- Fiberglass
- All Plastic Construction
- Collapse Rating - 145 psid
- 3, 5, 10, & 20 micron
- Filtration Rating  $\beta_{x(c)} \geq 1000$
- Depth Filtration
- Disposable



## Aquamicon® Elements

- AM - code designation
- Collapse Rating - 145 psid
- Undissolved (free) **Water Removal ONLY!**
- 40 micron
- Surface filtration
- Disposable



## Wire Mesh Elements

- W/HC - code designation
- Wire Mesh
- Collapse Rating - 290 psid
- 25, 50, 74, 100, 149, 200 micron
- Surface Filtration
- Cleanable
- Corrosion protection - Stainless Steel filter media and Tin/Nickel plated hardware



## Polyester Elements

- P/HC - code designation
- Polyester media - plastic coating eliminates swelling
- Collapse Rating - 145 psid
- 10 & 20 micron
- Surface Filtration
- Disposable
- Higher contamination retention than cellulose
- Low flow resistance = low  $\Delta P/Q$
- Media supported by wire mesh



## Metal Fiber Elements

- V - code designation
- Stainless Steel media; Tin plated steel hardware
- Collapse Rating - 3045 psid
- 3, 5, 10, & 20 micron
- High Efficiency Rated available on request 1, 3, 5, 10, & 20 micron (*Depth filtration optional*)
- Surface Filtration (*standard*)
- Cleanable
- High filtration efficiency curve even under extreme dynamic loads
- Low flow resistance = low  $\Delta P/Q$



## Mobilemicron Elements

- MM - code designation
- Melt blown - Fiberglass
- Extremely low clean element  $\Delta P$  / flow rate for cold start applications
- Filtration Efficiency Rating  $\beta_{x(c)} \geq 200$
- 8, 10, 15 micron
- Good Beta Stability
- Good Dirt Holding Capacity
- Collapse Rating - 145 psid
- Depth Filtration
- Disposable





# C Clogging Indicators

Early warning pressure devices protect the hydraulic circuit from contamination, alerting the operator that the filter element is near capacity and must be changed. The clogging indicator is typically set to trip at 1-bar (14 psid) below the filter bypass setting, to allow the operator sufficient time for element change-out. Available in visual, combo electrical/visual, as well as an extensive list of other options and certifications. A comprehensive offering of clogging indicators ensures that any application can be accommodated.

## Clogging Indicators Sections

Contents	Page:
<b>Introduction</b>	G2
<b>General Indicator Type Drawings</b>	G4
<b>Standard Indicators</b>	
Vacuum	G6
Return line	G8
Differential pressure	G21
<b>Mobile Indicators</b>	
Return line	G29
Differential pressure	G30
<b>ATEX Indicators</b>	
Return line	G32
Differential pressure	G34
<b>UL/CSA Indicators</b>	
Return line	G36
Differential pressure	G36
<b>Model Code - Standard</b>	G38
<b>Dual Indicator / Gauge Blocks</b>	G40

# FILTER CLOGGING INDICATORS

## Purpose of Indicators

Clogging indicators are warning devices that signal visually and/or electrically that the filter element is filled with contaminants and should be changed or cleaned. These devices activate (*trip*) when the flow of fluid causes a pressure drop across the filter element that exceeds the indicator setting. In filters that incorporate bypass valves, contaminated fluid will bypass the element if the operator does not respond to the indicator warning signal within a reasonable time. In non-bypass filters, if the indicator warning is not heeded, the pressure across the filter will build up to the point where system performance is degraded, the element fails, or the system relief valve is actuated.

The indicator is set to trip well before the element becomes fully clogged (*14 psid / 1 bar lower than bypass*), thereby giving the operator sufficient time to take corrective action. The indicator warning may be a visual signal at the filter site (*pop-up button, light, etc.*); or, some form of signal at a remote location (*trouble light, sound alarm, etc.*). In some critical applications, where contamination is intolerable, the signal from the indicator may be used to shut down the system so that personnel must immediately service the unit.

Some users install filters without indicators, preferring instead to change and/or clean elements according to a fixed time schedule — or based on number of hours of operation. There is some risk in utilizing this approach. It may be difficult to establish a reliable schedule for installing new elements because the rate of dirt ingress is not known, and, in fact, may vary from time-to-time and from machine-to-machine. Use of a clogging indicator has two main benefits: first, it eliminates the need to guess when the element will clog; second, it avoids the unnecessary cost of replacing elements too soon.

## Indicator Settings

In a majority of applications, a HYDAC indicator is set to trip at 15 psid (1 bar) below the bypass valve cracking pressure; or, for a non-bypass filter, at 15 psid below the element design changeout pressure. Typically, a HYDAC pressure filter bypass valve begins to crack at 87 psid (6 bar), so the indicator is set to trip at 72 psid (5 bar). A HYDAC return filter ordinarily begins to bypass at 43 psid (3 bar), so the indicator is set to trip at 29 psid (2 bar). Consequently, the operator has a period of time in which to change or clean the element before the bypass valve opens and passes contaminated fluid to sensitive components downstream of the filter.

Typically, the time from indication to bypass is 5-15% of the life of the element. For instance, if the normal service life of the element is 100 days, there is a grace period of 5-15 days before the filter begins bypassing. Nevertheless, it is advisable to change the element as soon as the indicator trips.

Non-standard indicator settings are often employed for various reasons. For instance, in lubrication systems, filters may not be allowed to have a high pressure drop, therefore, the indicator may be set to trip at less than 15 psid. When the filter is installed on the suction side of a pump, it is a common practice to limit the  $\Delta P$  across the filter to 3 psid, and to set the indicator at a correspondingly low amount.

Certain HYDAC non-bypass filters, such as the DFDK duplex series and DFZ series of sandwich filters, utilize indicators that are set at 116 psid (8 bar) in order to maximize the dirt retention and service life of the elements.

In most cases, HYDAC pressure and return line filters bypass at higher pressures than other commonly used filters, meaning that indicator settings also are higher than usual. This has the advantage of extending element service life.

## Types of Indicators

Filter assemblies may be ordered with or without indicators. When ordered with an indicator, the assembly model code includes a letter symbol for the indicator, such as B, C, or D. When ordered separately, an indicator has its own complete model code, as described subsequently in this brochure.

A type B or BM visual indicator is suitable when only a local warning is required. When it is necessary to signal a remote warning device, control panel, or PLC, one of the electric switches should be specified. Various kinds of switches are available to provide a range of electrical configurations, contact ratings, and connections.

The D indicator incorporates a switch and built-in light for both local and remote warning signals.

## Special Indicators

### Mobile indicators

These indicators have been developed for special applications and are fitted with AMP, Deutsch and Junior Power Timer plugs.

### ATEX indicators

These indicators are used in potentially explosive locations and are subject to the ATEX Equipment Directive 94/9/EC and the ATEX Operator Directive 1999/92/EC.



### UL and CSA indicators

Indicators which are exported to the USA and Canada often require classification according to current UL and CSA standards. The UL and CSA symbols are found on many products, particularly in the field of electrical engineering.



## Key Features

### Automatic vs. Manual Reset

All indicators with electric switches reset automatically to their original position when the pressure across the filter drops below trip pressure. This is true, also, for the type B visual indicator. However, on the type BM visual indicator with manual reset, the signal arm extends once the trip pressure is exceeded and remains that way until physically reset. The advantage is that the indicator signals that the element is dirty even after the system is shut down, thus, simplifying maintenance.

### Thermal Lockout

When mobile and other equipment is started in the cold, the hydraulic or lube fluid is likely to be highly viscous until it approaches normal operating temperature. The high pressure drop created by a highly viscous fluid can trip the indicator and falsely signify that the element is clogged. An optional thermal lockout device, available on many HYDAC electric indicators, prevents the indicator from tripping until the fluid reaches a certain specified temperature. The device consists of a switch in series in the indicator circuit, which is caused to make or break by a bi-metal strip that alters in shape according to temperature.

The thermal lockout feature may be chosen so that the indicator is deactivated at a fluid temperature less than  $100^{\circ}\text{F} \pm 5^{\circ}$  (called *T100*).

Because electric indicators automatically reset once the fluid heats up, thermal lockout is necessary only when a false signal of filter condition during cold start-up poses a problem.

### Single Pole, Double Throw Switches (SPDT)

HYDAC's differential pressure and most static pressure electrical indicators contain single-pole, double-throw switches. This provides the choice of normally open or normally closed contacts when the pressure differential is below trip-point.

Whether the contacts are normally open (*N/O*) or normally closed (*N/C*) is determined by the way in which the indicator is wired on site. This applies to types C, D, J, J4, LE, and LZ.

### Magnetic Coupling

Most of HYDAC's indicators employ magnetic coupling, which separates the fluid from the actuating device. The benefit is that there is no need for a dynamic seal, therefore, far less chance of fluid leakage under high system pressure.

## Interchangeability

HYDAC indicators are designed for use only with HYDAC filters, and should not be applied to other makes of filters.

Certain differential pressure indicators can be used in non-filter applications when mounted on special blocks. Detailed information regarding blocks of various kinds is presented subsequently in this brochure.

## Operation

In the drawings on the following page, examples of two types of differential pressure indicators and a static pressure indicator are provided.

### Application Guidelines

Differential pressure indicators react to the pressure drop across the filter that is caused by the flow of fluid through the filter housing and element. These devices measure the difference in pressure upstream and downstream of the filter element, regardless of the system pressure. They are utilized in most pressure and inline return filters.

Static pressure indicators measure only the build-up of pressure upstream of the filter element (*downstream pressure is ambient - tank vented to atmosphere*). Consequently, if any components are located downstream of the filter, the indicator will measure the pressure drop caused by the filter and that component, thus, causing a false reading of  $\Delta P$  across the filter. As a result, static indicators are recommended only on filters that discharge directly to vented tanks and have minimal back pressure.

A filter that incorporates a differential pressure indicator should be used whenever there is a significant resistance to flow in the line after the filter, even when system pressure is relatively low. For example, the filter in the feed line of a lube system requires a differential pressure indicator, although the system pressure may be low.

### Differential Pressure Indicator Operation

As the differential pressure across the filter increases, the piston / magnet assembly is driven down against a spring until the attractive force between the magnet and indicator pin (*Type 1*) or a switch actuator lever (*Type 2*) is reduced sufficiently to allow the indicator to trip. In a visual indicator (*Type 1*), tripping results in the indicator pin rising and giving visual indication that the filter must be serviced. In an electric indicator (*Type 2*), tripping causes a switch to make or break, permitting a remote indication to warn of the need for servicing. When the  $\Delta P$  drops below the trip pressure for any reason, (*installation of a clean element, heating of the oil, etc.*), the piston/ magnet assembly returns to its original position.

With a visual indicator, the pop-up indicator pin may then respond in one of two ways: (1) With Manual Reset (*type BM*) the pin remains extended, even after the system is shut down, and must be physically pushed down to reset (2) With Automatic Reset (*type B*) the indicator pin retracts to its original position along with the piston. With all electric indicators, the circuit is automatically restored to its original normally closed or normally open position once the  $\Delta P$  drops below the trip setting.

### Static Pressure Indicator Operation

Increasing pressure upstream of the filter acts upon a diaphragm in the indicator (*Type 3*) and causes the indicator pin to overcome an opposing spring force until it trips at a pre-set pressure. The indicator pin automatically resets once pressure is reduced below the trip pressure. Electric static pressure indicators, which also operate mechanically, are available as well. These too, reset automatically.

Note: Certain indicators have a red/ yellow/ green display in addition to, or instead of, the pop-up indicator pin.

# FILTER CLOGGING INDICATORS

## General Indicator Type Drawings:

### TYPE 1 Differential Pressure

#### Visual Indicator (B/BM)

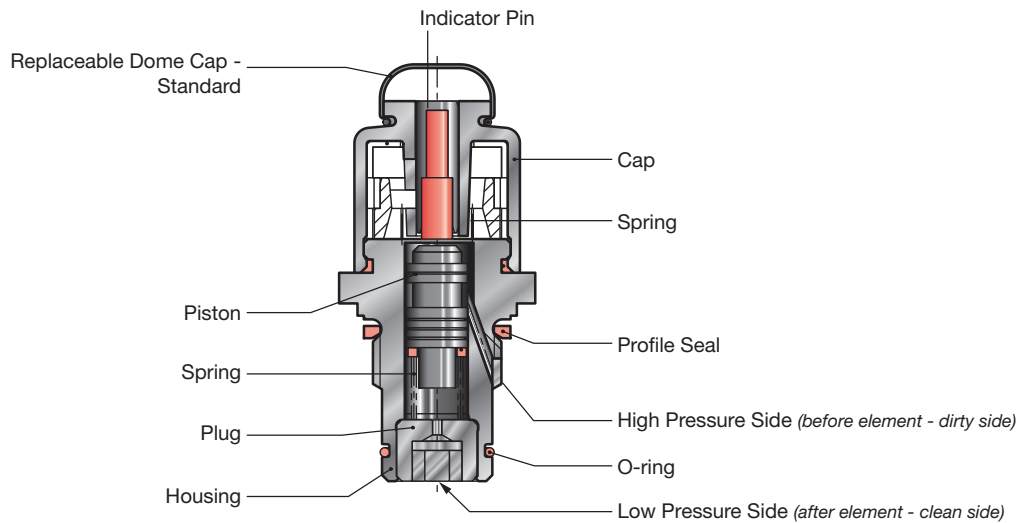

### TYPE 2 Differential Pressure

#### Electric Indicator (C or D)

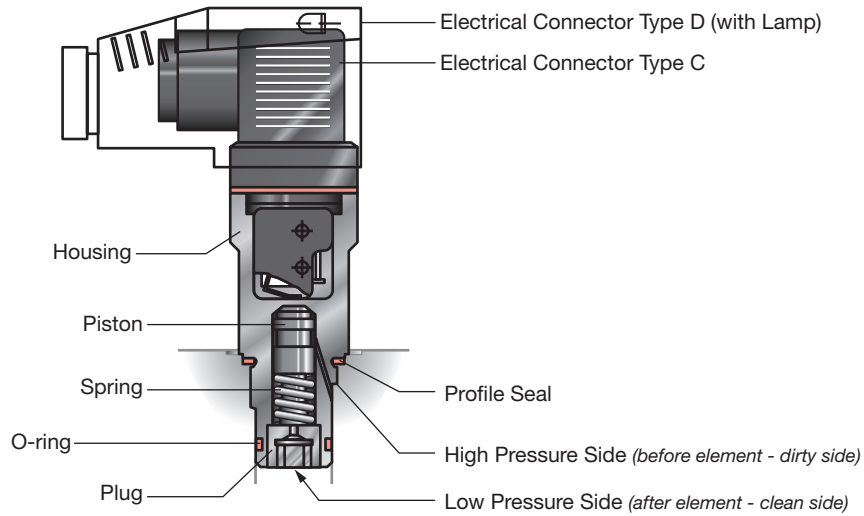

### TYPE 3 Static Pressure

#### Visual Indicator (B/BM)

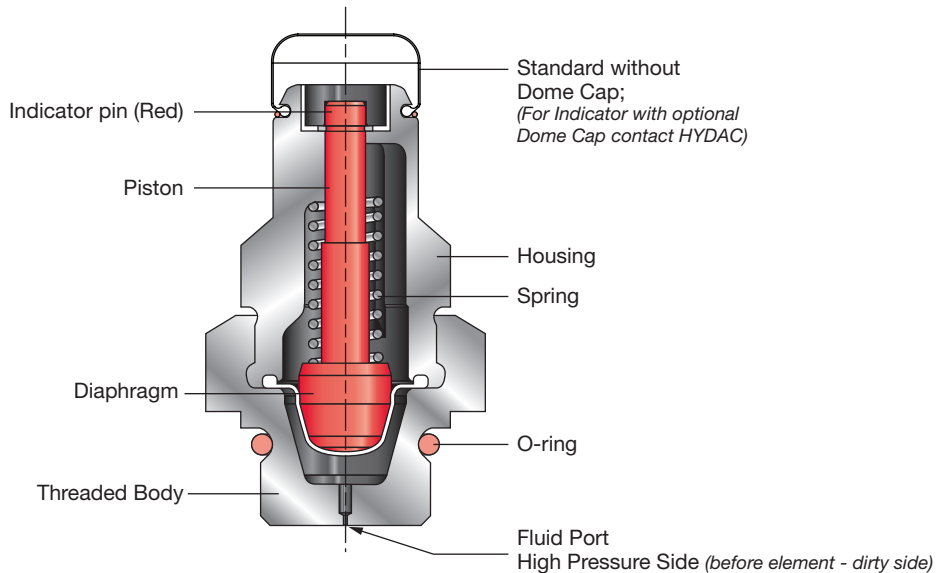



## Model Code: Standard Clogging Indicators

**VR 2 D . X /-V-L24**

### Category

- VMF = Return line (*static*) indicator; connection G 1/8
  - VR = Return line (*static*) indicator; connection G 1/2
  - VM = Differential pressure indicator; up to 3000 psi (210 bar) operating pressure
  - VD = Differential pressure indicator; up to 6000 psi (420 bar) operating pressure
  - VL = Differential pressure indicator; up to 360 psi (25 bar) operating pressure
- } G 1/2

### Pressure setting

- 1 = 15 psi (1 bar) (*optional, for use in lube applications*) - (not available with all types- Consult HYDAC)
- 2 = 29 psid (2 bar) (*standard, for use on return line filters*)
- 5 = 72 psid (5 bar) (*standard, for use on pressure filters, except DFDK & DFZ*)
- 8 = 116 psid (8 bar) (*standard, on DFDK & DFZ filters*) - (not available with all types- Consult HYDAC)

### Type

- B = Visual pop-up with automatic reset
- BF = Visual, mobile applications
- BM = Visual pop-up with manual reset
- C = Electrical switch
- CD = Electrical switch with Deutsch plug (*DT 04-2P*)
- D = Electric switch and Visual (*light - 24 VDC, 110 VAC*)
- E = Pressure gauge, horizontal (*static only*)
- ES = Pressure gauge, vertical
- F = Pressure switch, mobile applications
- FD = Pressure switch with Deutsch plug (*DT 04-2P*), mobile applications
- GC = Electronic analog (*4-20 mA or 1-10 V*) / pressure switch 75% and 100% trips (*VD & VR only*)  
**Discontinued (consult HYDAC for suitable replacements)**
- GW = Electronic analog (*4-20 mA or 1-10 V*) / pressure switch 75% and 100% trips & bypass monitoring (*VL only*)
- J = Electric switch - Brad Harrison 5-pin mini connector
- J4 = Electric switch - Brad Harrison 4-pin micro connector
- LE = Electric pressure switch / visual pop-up button with 100% switching contact
- LEM = Electric pressure switch / visual pop-up button with 100% switching contact and M12x1 plug, mobile applications
- LZ = Electric pressure switch / visual pop-up button with 75% and 100% switching contact
- M = Electrical, ground switching
- UE = Vacuum pressure gauge, horizontal
- UF = Vacuum switch

### Modification Number

- X = The latest version is always supplied

### Supplementary Details

- T100 = Lockout below 100°F (VM, VD – types C, D, J and J4 only)
- 30C = Cold start suppression of switching outputs up to 30°C ±5°C  
(*only for C, D, LZ indicators; DC voltage supply only – max. 24 Volt; C and D indicators only for VD and VM; on D and LZ indicators, contacts must be wired N/O only*)
- L... = Light with corresponding voltage (*24, 48, 110, 230 Volt*) } only for type "D"
- LED = 2 LEDs up to 24 Volt
- OE = N/C function
- SO135 = Indicator suitable for PLC controls (*Gold-Crosspoint contacts*)
- W = Suitable for oil/water emulsions (HFA, HFC)
- V = Fluorocarbon elastomer (FKM), suitable for phosphate esters (HFD-R) and biodegradable oils (*must be specified for type "GW"*)  
Nitrile (NBR) is standard. Ethylene propylene (EPDM, code EPR) available upon request.
- 2M0 = Two contacts (*male*), 2-pin Deutsch connector, no connector cable
- 2M20 = Two contacts (*male*), 2-pin Deutsch connector, 200 mm connector cable

### Supplementary Details for "GC" type **Discontinued (consult HYDAC for suitable replacements)**

- SP = Analog signal: output 1-10 V } if SP or SQ are not specified
- SQ = Analog signal: output 4-20 mA (*current source*) } "current sink" model supplied
- 113 = N/O function - pressure peak suppression up to 10 sec.  
Cold start suppression of switching outputs  
(*PNP technique, positive switching*) up to 25°C } **Must be specified!**  
Others on request
- 123 = N/C function - pressure peak suppression up to 10 sec.  
Cold start suppression of switching outputs  
(*PNP technique positive switching*) up to 25°C } **Must be specified!**  
Others on request
- 30C = Cold start suppression of switching outputs up to 30°C (*other temperatures on request*)
- LED = 3 LED's (*green, yellow, red*) in terminal box
- PF = Floating switching outputs (due to relay in the plug)

### Supplementary Details to "GW" type

- 113 = N/O function - pressure peak suppression up to 10 sec.  
Cold start suppression of switching outputs  
(*PNP technique positive switching*) up to 25°C } **Must be specified!**  
Others on request
- 123 = N/C function - pressure peak suppression up to 10 sec.  
Cold start suppression of switching outputs  
(*PNP technique positive switching*) up to 25°C } **Must be specified!**  
Others on request

# FILTER CLOGGING INDICATORS

## Supplementary Details for “LZ” type

- AV = Plug and connector to AUDI, VW specification
- BO = Plug and connector to BMW, Opel, Ford specification
- BO-LED = Same as BO, but with progressive LED strip
- CN = Electrical connection, 1 connector DIN 43651 with 3 LEDs (*to CNOMO specification NF E 48-700*)
- DB = Electrical connection, 1 connector to DIN 43651 with 3 LEDs (*to Daimler-Benz and BMW specification*)
- D4C = Plug and connector to Daimler-Chrysler specification with cold start suppression 30 °C

## Supplementary Details to “ATEX” type

- 2GC = For visual indicator type “B” with ATEX certificate
- 2GBC = For electrical indicator type “C” with ATEX certificate (*the switch used in the indicator is a passive component according to EN 50020 and can therefore be used in intrinsically safe circuits as simple apparatus in accordance with EN 60079-14*)
- 2GEXDIIC = For electrical indicator suitable for use in Zone 1 (*Category 2*), gas atmosphere, Category d (*Flameproof Enclosure*), Explosive subdivision IIC to ATEX directive
- EX2G = Ex-protection type for the return line indicator type “C”

## Supplementary Details for “UL” and “CSA” approval

- cRUus = For electrical differential indicator type “C” and “D” with UL Underwriter’s Recognition
- CSA = For electrical return line indicator type “C” with CSA approval

Notes: 1. Old style indicators for filters HF2P / HF3P / HF4P - pre 2008 (Example **Model Code: B2210BHF**), contact HYDAC for further information.

2. VMF indicators of type B, LE, LZ, and C I-EX2G, must include “V” at the end of the Model Code if Fluorocarbon elastomer (FKM) seals are required. All other VMF indicators come with Fluorocarbon elastomer (FKM) seals as a standard (*no Supplementary Detail required*).

## Dual Indicator / Gauge Blocks

### Dual Gauge Block - G 1/2 Differential Indicator Port to SAE-4 or 1/4 NPT Ports (Part No. 02061666 & 02061667 with FKM seals)

#### Remote-mount Applications:

- Use Part No. 02061666 / 02061667 / 319004 in filter head
- Use Part No. 02080588 / 318740 in remote location
- Keep pipe run below 10 ft.

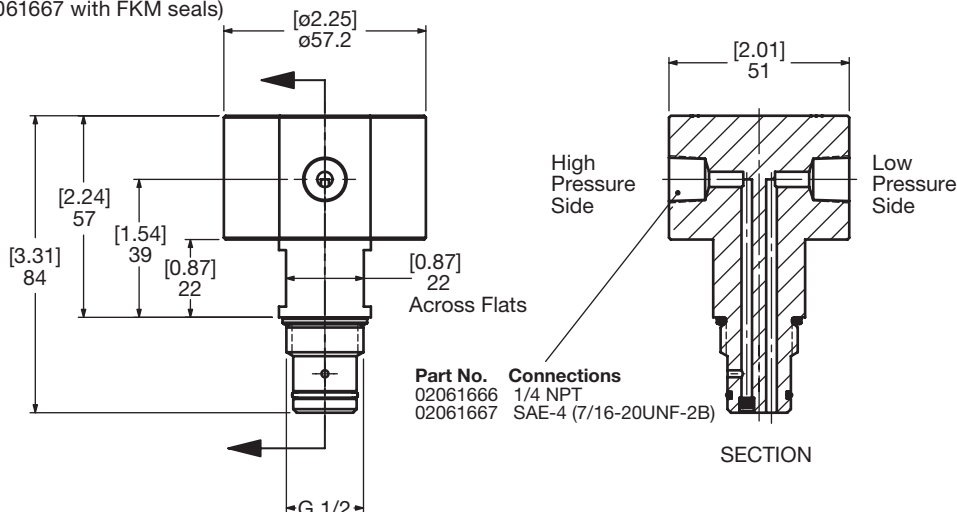

### Dual Gauge Block - 3/4-16UNF-2A Differential Indicator Port to SAE-4 Ports (Part No. 02059931 with FKM seals)

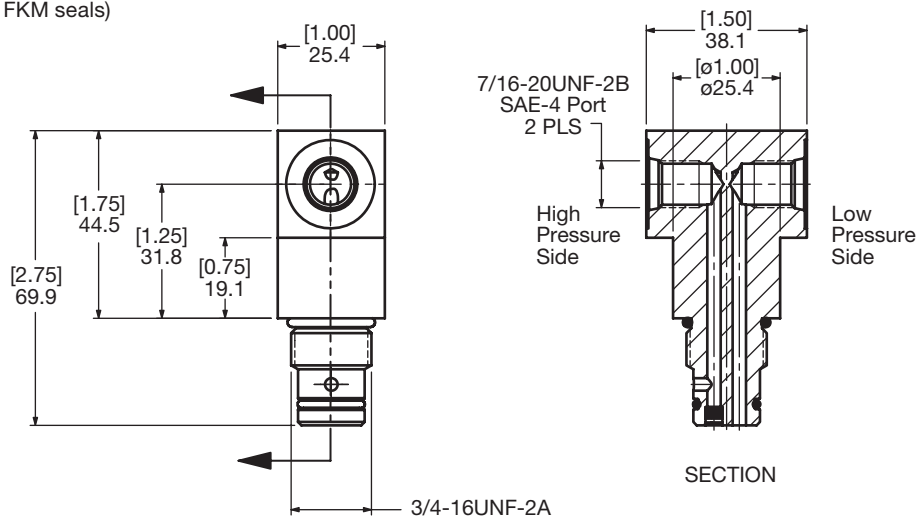

### Adapter - Static - G 1/2" to G 1/8"

(Part No. 319004 w/NBR seal)

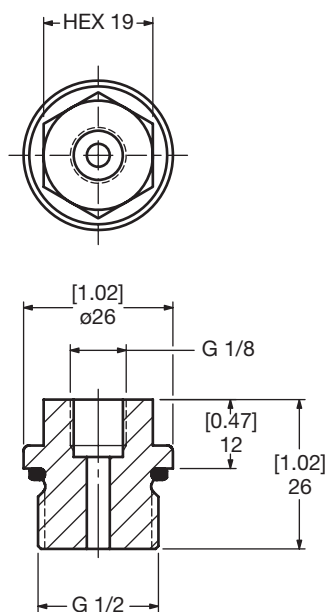

### Adapter - Static - G 1/8" to G 1/2"

(Part No. 318740)

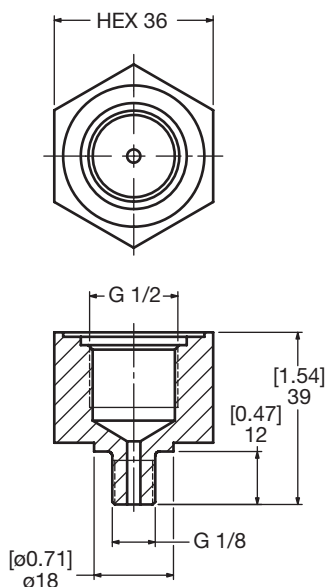

### Pipe Connection Block - SAE-4 Ports to G1/2 Differential Indicator Port (Part No. 02080588)

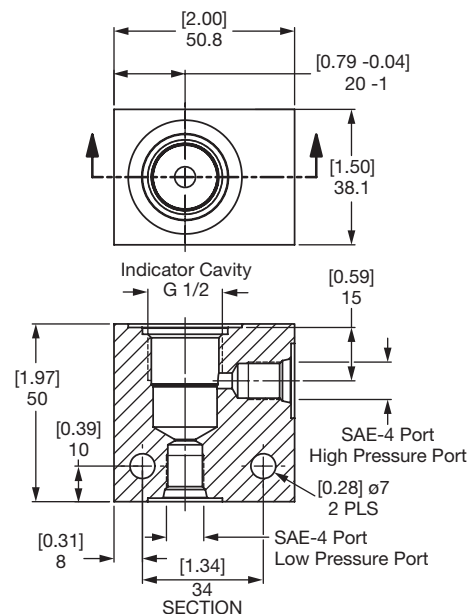

Note: Can be used as a test block

# FILTER CLOGGING INDICATORS

**Dual Indicator Block- Static - G 1/2 port to 2 x G 1/2 ports**  
(Part No. 00318741 with NBR seal)

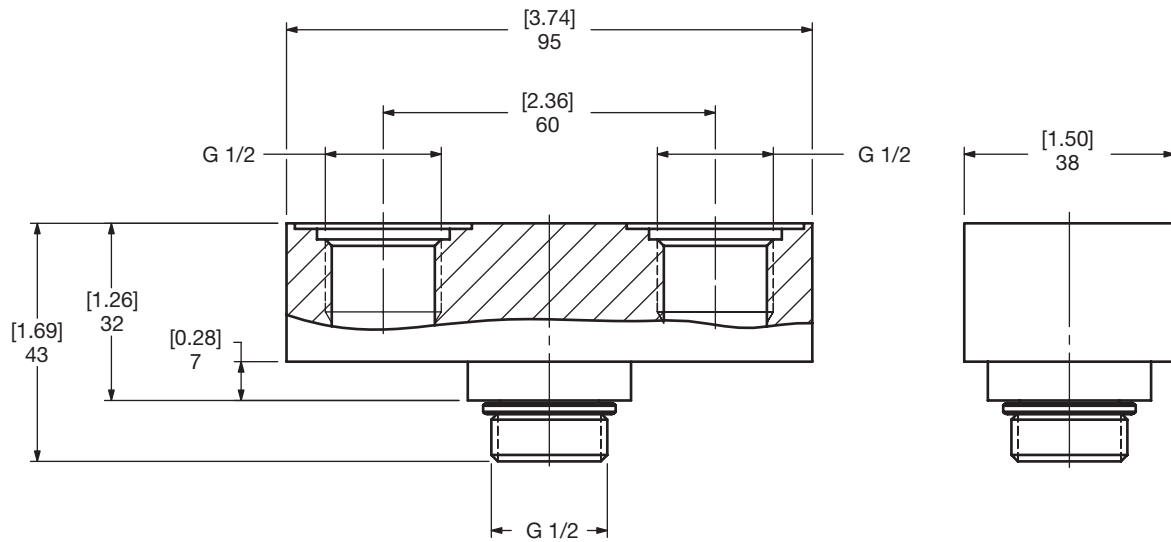

**Dual Indicator Block- Differential - G 1/2 Indicator Port to 2 x G 1/2 Indicator Ports**  
(Part No. 00318732 with NBR seals)

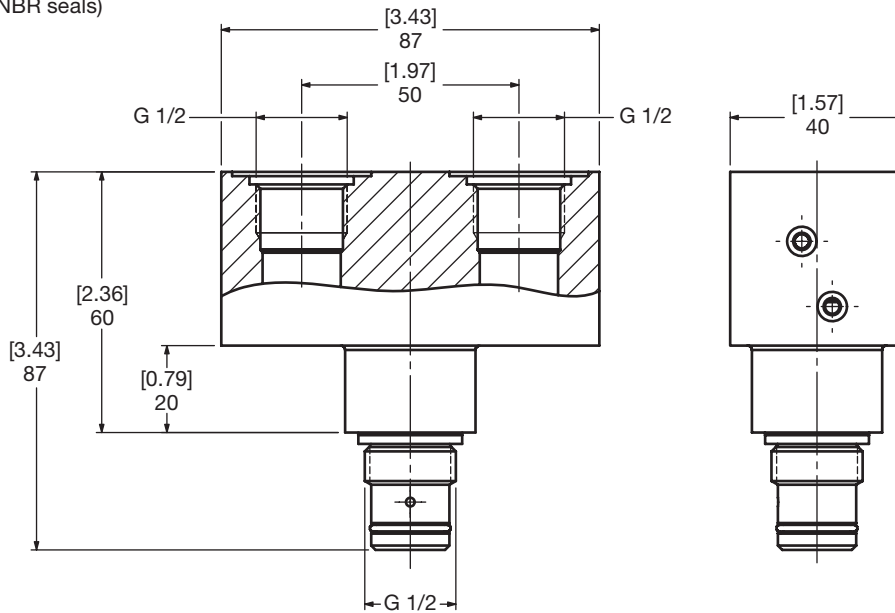

# FILTER CLOGGING INDICATORS

## INDICATOR INSTALLATION INFORMATION FOR FILTERS

	Indicator Series	Indicator Type	Tightening Torque (lbf-ft)				Sealing						
			Material of the Indicator Ported Part										
			Steel	Ductile Iron	Aluminum	Plastic (Nylon)							
<b>STATIC INDICATORS</b>	<b>VMF</b>	A (G 1/8" VSTI PLUG)	11	11	7.5	NOT APPLICABLE	No elastomeric seals included with indicator. When sealing indicator to static indicator port, apply Loctite 542 or equivalent thread locker and sealant to indicator port threads and tighten to recommended torque. Allow a minimum of 24 hours for full curing of thread locker and sealant.						
		B/BM											
		C/CM											
		D											
		E/ES											
		F/FA/FD/FF/FJ/FM/FS											
		K											
		LE/LEC/LEM/LZ											
		M											
		R/RS											
		UBM											
		UC/UCM											
	<b>VR</b>	A	37	37	24	7.5	Elastomeric seal included.						
		B/BM											
		C/CM											
		D											
		E/ES											
		F/FA/FD/FF/FJ/FM/FS											
		GC*											
		LE/LEC/LEM/LZ											
		K											
		R/RS											
		UC/UCM											
		UE/UED											
	UF/UFJ												
	<b>VRD</b>	C/CM	37	37	24	7.5	Elastomeric seal included.						
		D											
		E/ES											
		K											
		F/FA/FD/FF/FJ/FM/FS											
		R/RS											
		UC/UCM											
		UE/UED											
UF/UFJ													
<b>DIFFERENTIAL INDICATORS</b>	<b>VD</b>	A	74	74	24	NOT APPLICABLE	Elastomeric seal included.						
		B/BM											
		C/CA/CC/CD/CJ/CM/CS/CW											
		D											
		B/BM (W Option)											
		C/CA/CC/CD/CJ/CM/CS/CW (W Option)											
		D (W Option)											
		GC*											
		LE/LEC/LEM/LZ											
	<b>VM</b>	B/BM	24	24	24	7.5	Elastomeric seal included.						
		C/CA/CC/CD/CJ/CM/CS/CW											
		D											
		GM											
		M											
		MB/MBM											
		MC/MCD/MCJ											
		<b>B...MF</b>						B	N/A	N/A	24	N/A	Elastomeric seal included.
								LE*					
C													

\*Discontinued (consult HYDAC for suitable replacements)

This drawing is PROPRIETARY. Distribution, reproduction or disclosure of information pertaining to this drawing to any party other than those directly working with HYDAC is strictly prohibited without the written consent of HYDAC.



## **D** Quick Reference Guide

Quick Reference is an easy one-stop general selection guide. Broken down by operating pressure (low, medium, high), filter type (inside-tank, in-tank, inline, duplex, manifold-mount, etc.), maximum flow rate, port size, and flow path; Quick Reference narrows down the selection into one or more filter series suitable for the application. Catalog page numbers are also provided so that the desired filter series data sheet can be found with ease.

# QUICK REFERENCE

## Low Pressure Filters

(Click on any filter for more detailed information.)

**RFM...S SPECIAL ORDER FILTER - Minimum order quantities and/or extended lead times will apply (consult HYDAC Product Management)**

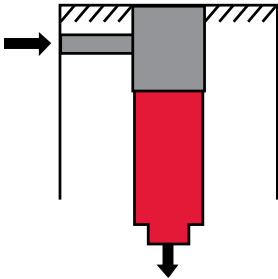
	<b>Filter Type</b>	Inside Tank	<b>Flow Path</b> 
	<b>Maximum Pressure psi (bar)</b>	145 (10)	
	<b>Maximum Flow gpm (l/min)</b>	43 (165)	
	<b>Port Size Range (in)</b>	2 (outlet)	
	<b>Indicator</b> D = Diff. S = Static	S	
	<b>Filter Model Page</b>	page H2	
	<b>Features</b>	Unique design places entire filter inside of the reservoir tank. Consult Factory.	

**RFM...Set SPECIAL ORDER FILTER - Minimum order quantities and/or extended lead times will apply (consult HYDAC Product Management)**

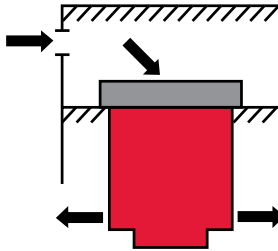
	<b>Filter Type</b>	Inside Tank	<b>Flow Path</b> 
	<b>Maximum Pressure psi (bar)</b>	145 (10)	
	<b>Maximum Flow gpm (l/min)</b>	132 (500)	
	<b>Port Size Range (in)</b>	1.26 (outlet)	
	<b>Indicator</b> D = Diff. S = Static	S	
	<b>Filter Model Page</b>	page H2	
	<b>Features</b>	Unique design places entire filter inside of the reservoir tank plenum. Consult Factory. Ideal for low tank top clearances and multiple inlets to reservoir.	

**RKT SPECIAL ORDER FILTER - Minimum order quantities and/or extended lead times will apply (consult HYDAC Product Management)**

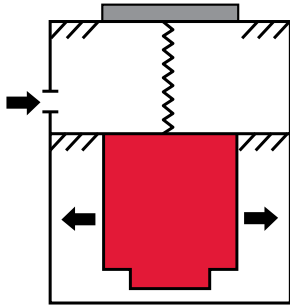
	<b>Filter Type</b>	Inside Tank	<b>Flow Path</b> 
	<b>Maximum Pressure psi (bar)</b>	145 (10)	
	<b>Maximum Flow gpm (l/min)</b>	317 (1200)	
	<b>Port Size Range (in)</b>	shroud	
	<b>Indicator</b> D = Diff. S = Static	S	
	<b>Filter Model Page</b>	page H12	
	<b>Features</b>	Optimized system size and performance through air separation technology and versatile return flow options.	

**RKB SPECIAL ORDER FILTER - Minimum order quantities and/or extended lead times will apply (consult HYDAC Product Management)**

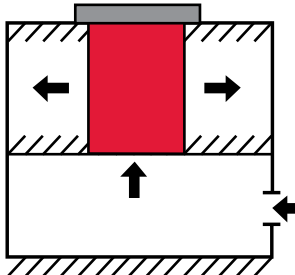
	<b>Filter Type</b>	Inside Tank	<b>Flow Path</b> 
	<b>Maximum Pressure psi (bar)</b>	145 (10)	
	<b>Maximum Flow gpm (l/min)</b>	317 (1200)	
	<b>Port Size Range (in)</b>	shroud	
	<b>Indicator</b> D = Diff. S = Static	S	
	<b>Filter Model Page</b>	page H24	
	<b>Features</b>	Optimized system size and performance in large return flow applications, through air separation technology and versatile return flow options.	



*(Click on any filter for more detailed information.)*

## RF

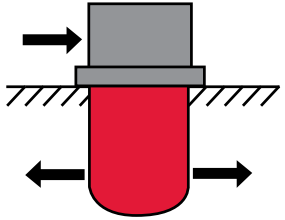
	<b>Filter Type</b>	In-Tank	<b>Flow Path</b> 
	<b>Maximum Pressure psi (bar)</b>	360 (25)	
	<b>Maximum Flow gpm (l/min)</b>	343 (1300)	
	<b>Port Size Range (in)</b>	1/2 - 4	
	<b>Indicator</b> D = Diff. S = Static	S D-size 660 & up with DE option	
	<b>Filter Model Page</b>	page D2	
	<b>Features</b>	HYDAC standard in-tank/in-line filters. Threaded or flanged outlets and one piece casting enable in-line use. Robust design.	

## NF\*

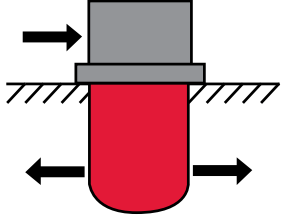
	<b>Filter Type</b>	In-Tank	<b>Flow Path</b> 
	<b>Maximum Pressure psi (bar)</b>	360 (25)	
	<b>Maximum Flow gpm (l/min)</b>	450 (1700)	
	<b>Port Size Range (in)</b>	4	
	<b>Indicator</b> D = Diff. S = Static	S (in-tank; 1.x) D (in-line; 2.x)	
	<b>Filter Model Page</b>	page D72	
	<b>Features</b>	Configurable for in-tank or in-line applications. Low weight, water tolerant aluminum alloy-high flow capability.	

## RFM

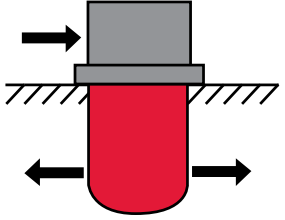
	<b>Filter Type</b>	In-Tank	<b>Flow Path</b> 
	<b>Maximum Pressure psi (bar)</b>	145 (10)	
	<b>Maximum Flow gpm (l/min)</b>	300 (1100)	
	<b>Port Size Range (in)</b>	3/4 - 2 1/2	
	<b>Indicator</b> D = Diff. S = Static	S	
	<b>Filter Model Page</b>	page D20	
	<b>Features</b>	In-tank low cost high performance mobile filters – Sizes 75, 90, 150, 165, & 185 have a built-in breather option. All sizes allow oil filling through element.	

## RFMP SPECIAL ORDER FILTER - Minimum order quantities and/or extended lead times will apply (consult HYDAC Product Management)

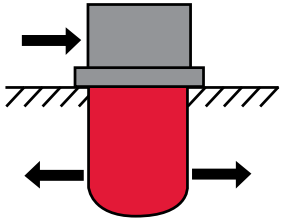
	<b>Filter Type</b>	In-Tank	<b>Flow Path</b> 
	<b>Maximum Pressure psi (bar)</b>	100 (7)	
	<b>Maximum Flow gpm (l/min)</b>	26 (100)	
	<b>Port Size Range (in)</b>	1" hose barb	
	<b>Indicator</b> D = Diff. S = Static	S	
	<b>Filter Model Page</b>	page H8	
	<b>Features</b>	In-tank return filter made of polyamide-housing and plastic lid-low cost.	

\*For a Set version of this filter, refer to Set Series section of the catalog.

## HF4R



<b>Filter Type</b>	In-Tank
<b>Maximum Pressure psi (bar)</b>	100 (7)
<b>Maximum Flow gpm (l/min)</b>	100 (378)
<b>Port Size Range (in)</b>	1 1/2
<b>Indicator</b> D = Diff. S = Static	S
<b>Filter Model Page</b>	page D36
<b>Features</b>	Meets HF4 automotive specs and uses industry standard-size HF4 spec elements. Threaded outlet permits in-line use.

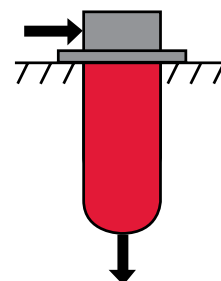

## RKM



<b>Filter Type</b>	In-Tank
<b>Maximum Pressure psi (bar)</b>	145 (10)
<b>Maximum Flow gpm (l/min)</b>	211 (800)
<b>Port Size Range (in)</b>	3/4 - 2 1/2
<b>Indicator</b> D = Diff. S = Static	S & Vac.
<b>Filter Model Page</b>	page D40
<b>Features</b>	Single filter functions as return line and charge pump filter in single housing. (up to two charge pumps)

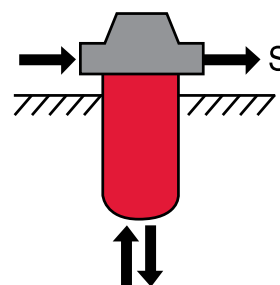

## RFT SPECIAL ORDER FILTER - Minimum order quantities and/or extended lead times will apply (consult HYDAC Product Management)



<b>Filter Type</b>	In-Tank
<b>Maximum Pressure psi (bar)</b>	145 (10)
<b>Maximum Flow gpm (l/min)</b>	634 (2400)
<b>Port Size Range (in)</b>	1 1/2 - 4 (inlet)
<b>Indicator</b> D = Diff. S = Static	S
<b>Filter Model Page</b>	page H30
<b>Features</b>	Top-tank filtration with air separation technology, designed for small and large return flow applications.

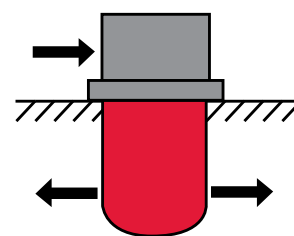

## RFB SPECIAL ORDER FILTER - Minimum order quantities and/or extended lead times will apply (consult HYDAC Product Management)



<b>Filter Type</b>	In-Tank
<b>Maximum Pressure psi (bar)</b>	145 (10)
<b>Maximum Flow gpm (l/min)</b>	158 (600)
<b>Port Size Range (in)</b>	1 3/8 (inlet)
<b>Indicator</b> D = Diff. S = Static	S
<b>Filter Model Page</b>	page H46
<b>Features</b>	Optimized system size and performance through air separation technology and versatile return flow options.

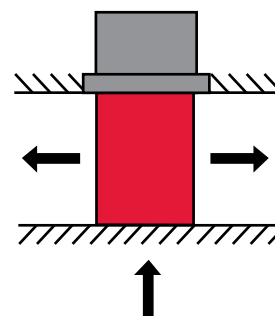

(Click on any filter for more detailed information.)

## RFD

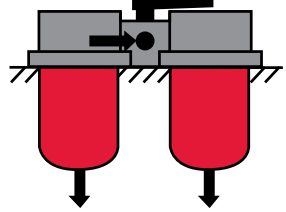
	<b>Filter Type</b>	In-Tank Duplex	<b>Flow Path</b>
	<b>Maximum Pressure psi (bar)</b>	360 (25)	
	<b>Maximum Flow gpm (l/min)</b>	343 (1300)	
	<b>Port Size Range (in)</b>	3/4 - 4	
	<b>Indicator</b> D = Diff. S = Static	S	
	<b>Filter Model Page</b>	page D12	
<b>Features</b>	For return lines in continuously operating systems; tank mounting or in-line due to one piece casting.		

## NFD

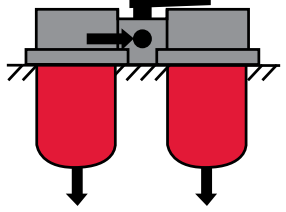
	<b>Filter Type</b>	In-Tank Duplex	<b>Flow Path</b>
	<b>Maximum Pressure psi (bar)</b>	360 (25)	
	<b>Maximum Flow gpm (l/min)</b>	450 (1700)	
	<b>Port Size Range (in)</b>	4	
	<b>Indicator</b> D = Diff. S = Static	S (1.x) D (2.x)	
	<b>Filter Model Page</b>	page D86	
<b>Features</b>	For return lines in continuously operating systems; tank mounting (1.x) and in-line (2.x).		

## RFL Cast

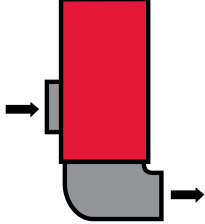
	<b>Filter Type</b>	In-Line	<b>Flow Path</b>
	<b>Maximum Pressure psi (bar)</b>	360 (25)	
	<b>Maximum Flow gpm (l/min)</b>	350 (1325)	
	<b>Port Size Range (in)</b>	3, 4	
	<b>Indicator</b> D = Diff. S = Static	D	
	<b>Filter Model Page</b>	page D145	
<b>Features</b>	Back Mount single filter with metric threads.		

## RFL Welded

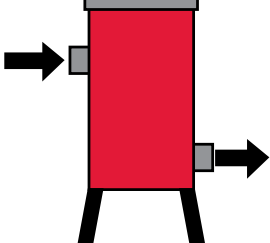
	<b>Filter Type</b>	In-Line	<b>Flow Path</b>
	<b>Maximum Pressure psi (bar)</b>	145 / 232 (10 / 16)	
	<b>Maximum Flow gpm (l/min)</b>	3963 (15000)	
	<b>Port Size Range (in)</b>	2 - 12	
	<b>Indicator</b> D = Diff. S = Static	D	
	<b>Filter Model Page</b>	page D155	
<b>Features</b>	Floor mounted. Holds up to ten 2600 high capacity elements. ASME and CRN versions available. For High flow applications.		

## FLN (with DIN option)

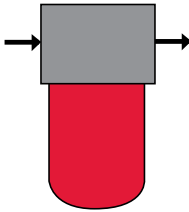
	<b>Filter Type</b>	In-Line	<b>Flow Path</b> 
	<b>Maximum Pressure psi (bar)</b>	360 (25)	
	<b>Maximum Flow gpm (l/min)</b>	105 (400)	
	<b>Port Size Range (in)</b>	1 1/4 - 1 1/2	
	<b>Indicator</b> D = Diff. S = Static	D	
	<b>Filter Model Page</b>	page D64	
	<b>Features</b>	Low pressure filter. Low weight, water-tolerant aluminum alloy. DIN option available.	

## NFH (modular)

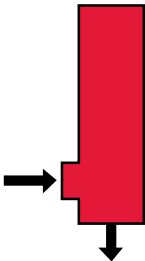
	<b>Filter Type</b>	In-Line	<b>Flow Path</b> 
	<b>Maximum Pressure psi (bar)</b>	500 (34.5)	
	<b>Maximum Flow gpm (l/min)</b>	450 (1700)	
	<b>Port Size Range (in)</b>	4	
	<b>Indicator</b> D = Diff. S = Static	D	
	<b>Filter Model Page</b>	page D94	
	<b>Features</b>	Filters can be manifolded for high viscosity applications. Housings designed for high flow up to 450 gpm, and/or high viscosity fluid (e.g. in lube systems).	

## NF...UHE

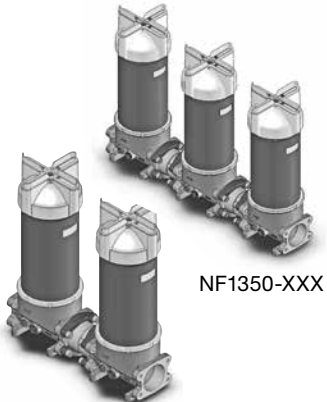
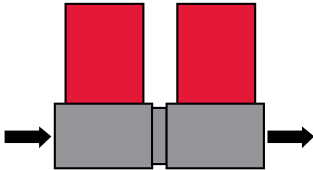
 <p>NF1350-XXX</p> <p>NF1350-XX</p>	<b>Filter Type</b>	In-Line Staged	<b>Flow Path</b> 
	<b>Maximum Pressure psi (bar)</b>	360 (25)	
	<b>Maximum Flow gpm (l/min)</b>	300 (1136)	
	<b>Port Size Range (in)</b>	2 - 4	
	<b>Indicator</b> D = Diff. S = Static	D	
	<b>Filter Model Page</b>	page D110	
	<b>Features</b>	Ultra-high efficiency staged filter combinations to increase separation efficiencies far above levels achieved by single elements, for cleaning fluids and transferring.	

## NFD...(UHE)

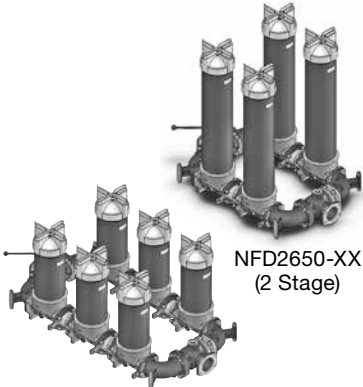
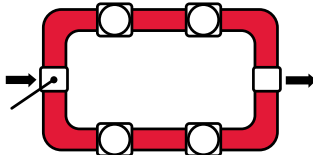
 <p>NFD2650-XX (2 Stage)</p> <p>NFD1350-XX (3 Stage)</p>	<b>Filter Type</b>	In-Line Staged	<b>Flow Path</b> 
	<b>Maximum Pressure psi (bar)</b>	360 (25)	
	<b>Maximum Flow gpm (l/min)</b>	300 (1136)	
	<b>Port Size Range (in)</b>	4	
	<b>Indicator</b> D = Diff. S = Static	D	
	<b>Filter Model Page</b>	page D125	
	<b>Features</b>	Ultra-high efficiency staged filter combinations to increase separation efficiencies far above levels achieved by single elements, for cleaning fluids and transferring.	

(Click on any filter for more detailed information.)

**NF MMP**

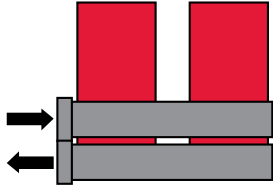
	<b>Filter Type</b>	In-Line Modular Manifold-Parallel	<b>Flow Path</b> 
	<b>Maximum Pressure psi (bar)</b>	360 (25)	
	<b>Maximum Flow gpm (l/min)</b>	1350 (5110)	
	<b>Port Size Range (in)</b>	4	
	<b>Indicator D = Diff. S = Static</b>	D	
	<b>Filter Model Page</b>	page D133	
<b>Features</b>	In-line manifolded modular parallel filter assemblies for high flow and high viscosity applications particularly in primary metals and pulp and paper applications. Fully isolatable in maintenance mode-element changeout.		

**RFLD Cast**

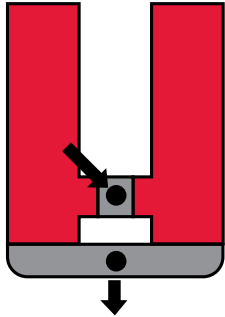
	<b>Filter Type</b>	In-Line Duplex	<b>Flow Path</b> 
	<b>Maximum Pressure psi (bar)</b>	360 / 580 (25 / 40)	
	<b>Maximum Flow gpm (l/min)</b>	343 (1300)	
	<b>Port Size Range (in)</b>	1 - 4	
	<b>Indicator D = Diff. S = Static</b>	D	
	<b>Filter Model Page</b>	page D149	
<b>Features</b>	Back mounted duplex filter with metric threads. Ball valve changeover.		

**RFLD Welded**

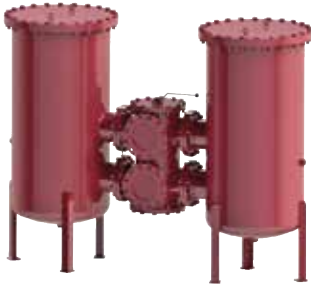
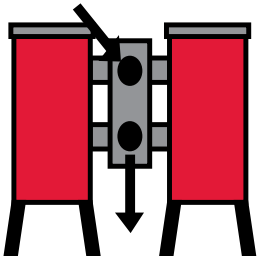
	<b>Filter Type</b>	In-Line Duplex	<b>Flow Path</b> 
	<b>Maximum Pressure psi (bar)</b>	145 / 232 (10 / 16)	
	<b>Maximum Flow gpm (l/min)</b>	3900 (14, 763)	
	<b>Port Size Range (in)</b>	2 - 8	
	<b>Indicator D = Diff. S = Static</b>	D	
	<b>Filter Model Page</b>	page D165	
<b>Features</b>	Floor mounted. Holds up to ten 2600 high capacity elements per side. ASME and CRN versions available. For high flow applications. Large ball valve changeovers available.		

**RFLDH Welded SPECIAL ORDER FILTER - Minimum order quantities and/or extended lead times will apply (consult HYDAC Product Management)**

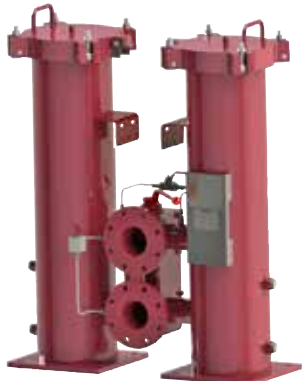
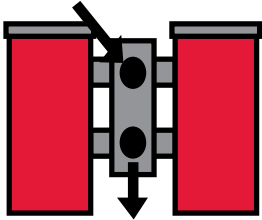
	<b>Filter Type</b>	In-Line Duplex	<b>Flow Path</b> 
	<b>Maximum Pressure psi (bar)</b>	145 (10)	
	<b>Maximum Flow gpm (l/min)</b>	793 (3000)	
	<b>Port Size Range (in)</b>	2 - 6	
	<b>Indicator D = Diff. S = Static</b>	D	
	<b>Filter Model Page</b>	page H54	
<b>Features</b>	Floor mounted. Holds up to 5 high cap. elements/side. ASME standard; Ball valve changeover. Carbon & stainless steel.		

**AFLD (API) SPECIAL ORDER FILTER - Minimum order quantities and/or extended lead times will apply (consult HYDAC Product Management)**

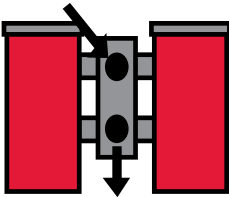
	<b>Filter Type</b>	In-Line Duplex	<b>Flow Path</b> 	
	<b>Maximum Pressure psi (bar)</b>	232 (16)		
	<b>Maximum Flow gpm (l/min)</b>	634 (2400)		
	<b>Port Size Range (in)</b>	1 - 6		
	<b>Indicator</b> D = Diff. S = Static	D		
	<b>Filter Model Page</b>	page H64		
	<b>Features</b>	In-line duplex filter series which are API 614 compliant. These filters are available with CRN, AS1210 and GOST certifications. Material certificate is standard.		

**FLND (with DIN option)**

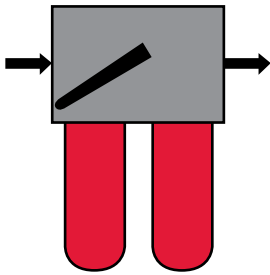
	<b>Filter Type</b>	In-Line Duplex	<b>Flow Path</b> 	
	<b>Maximum Pressure psi (bar)</b>	360 (25)		
	<b>Maximum Flow gpm (l/min)</b>	105 (400)		
	<b>Port Size Range (in)</b>	1 1/4 - 1 1/2		
	<b>Indicator</b> D = Diff. S = Static	D		
	<b>Filter Model Page</b>	page D68		
	<b>Features</b>	Integrated equalization valve with transfer valve. Light weight. CRN available. Water tolerant aluminum alloy. DIN option available.		

**NFHD**

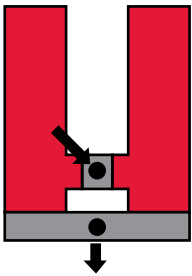
	<b>Filter Type</b>	In-Line Duplex	<b>Flow Path</b> 	
	<b>Maximum Pressure psi (bar)</b>	500 (34.5)		
	<b>Maximum Flow gpm (l/min)</b>	450 (1700)		
	<b>Port Size Range (in)</b>	4		
	<b>Indicator</b> D = Diff. S = Static	D		
	<b>Filter Model Page</b>	page D102		
	<b>Features</b>	Filters can be manifolded for high flow/viscosity applications in continuously operating systems.		

**SF SPECIAL ORDER FILTER - Minimum order quantities and/or extended lead times will apply (consult HYDAC Product Management)**

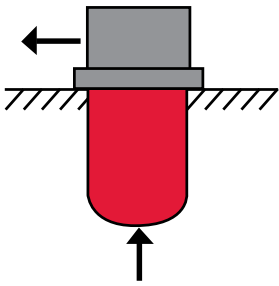
	<b>Filter Type</b>	In-Tank Suction	<b>Flow Path</b> 	
	<b>Maximum Pressure psi (bar)</b>	360 (25)		
	<b>Maximum Flow gpm (l/min)</b>	30 (114)		
	<b>Port Size Range (in)</b>	3/4 - 2		
	<b>Indicator</b> D = Diff. S = Static	Mechanical Bypass In Element		
	<b>Filter Model Page</b>	page H74		
	<b>Features</b>	Mounts in-tank. Modified vacuum gauge indicators are available.		

(Click on any filter for more detailed information.)

Spin-on Filters

MF 40

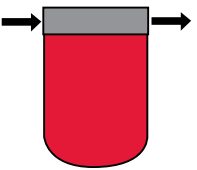
	<b>Filter Type</b>	Spin-On Single Element <i>(available in BSPP ports)</i>	<b>Flow Path</b>  
	<b>Maximum Pressure psi (bar)</b>	120 (8.3)	
	<b>Maximum Flow gpm (l/min)</b>	7 (26.5)	
	<b>Port Size Range (in)</b>	3/8	
	<b>Indicator</b> D = Diff. S = Static	N/A	
	<b>Filter Model Page</b>	page D54	
	<b>Features</b>	Standard length element. Not available with 3 µm Betamicon elements	

MF 80

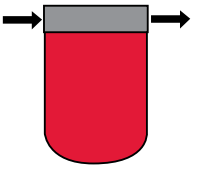
	<b>Filter Type</b>	Spin-On Single Element <i>(available in BSPP ports)</i>	<b>Flow Path</b>  
	<b>Maximum Pressure psi (bar)</b>	120 (8.3)	
	<b>Maximum Flow gpm (l/min)</b>	15 (57)	
	<b>Port Size Range (in)</b>	3/4 - 1	
	<b>Indicator</b> D = Diff. S = Static	S	
	<b>Filter Model Page</b>	page D54	
	<b>Features</b>	Standard length element. Not available with 3 µm Betamicon elements.	

MF 85

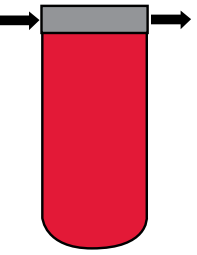
	<b>Filter Type</b>	Spin-On Single Element <i>(available in BSPP ports)</i>	<b>Flow Path</b>  
	<b>Maximum Pressure psi (bar)</b>	120 (8.3)	
	<b>Maximum Flow gpm (l/min)</b>	25 (95)	
	<b>Port Size Range (in)</b>	3/4 - 1	
	<b>Indicator</b> D = Diff. S = Static	S	
	<b>Filter Model Page</b>	page D54	
	<b>Features</b>	Extended length element. Same head as size 80. 10 µm paper elements only. 25 psid bypass standard.	

MF 160

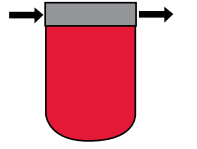
	<b>Filter Type</b>	Spin-On Single Element <i>(available in BSPP ports)</i>	<b>Flow Path</b>  
	<b>Maximum Pressure psi (bar)</b>	120 (8.3)	
	<b>Maximum Flow gpm (l/min)</b>	30 (113)	
	<b>Port Size Range (in)</b>	1 1/4 - 1 1/2	
	<b>Indicator</b> D = Diff. S = Static	S	
	<b>Filter Model Page</b>	page D54	
	<b>Features</b>	Standard length element.	

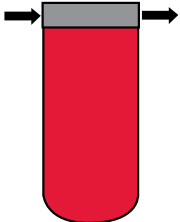
MF 180		Filter Type	Spin-On Single Element <i>(available in BSPP ports)</i>	Flow Path
	Maximum Pressure psi (bar)	120 (8.3)		
	Maximum Flow gpm (l/min)	60 (227)		
	Port Size Range (in)	1 1/4 - 1 1/2		
	Indicator D = Diff. S = Static	S		
	Filter Model Page	page D54		
	Features	Extended length element. Same head as size 160.		

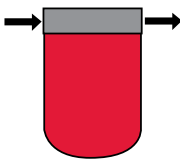
MF 190		Filter Type	Spin-On Single Element <i>(available in BSPP ports)</i>	Flow Path
	Maximum Pressure psi (bar)	120 (8.3)		
	Maximum Flow gpm (l/min)	30 (113)		
	Port Size Range (in)	1 1/4 - 1 1/2		
	Indicator D = Diff. S = Static	D		
	Filter Model Page	page D54		
	Features	Standard length element. ΔP Sensing Indicators for applications where tank not vented to atmosphere.		

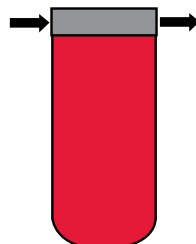
MF 195		Filter Type	Spin-On Single Element <i>(available in BSPP ports)</i>	Flow Path
	Maximum Pressure psi (bar)	120 (8.3)		
	Maximum Flow gpm (l/min)	60 (227)		
	Port Size Range (in)	1 1/4 - 1 1/2		
	Indicator D = Diff. S = Static	D		
	Filter Model Page	page D54		
	Features	Extended length element. Same head as size 190. ΔP Sensing Indicators for applications where tank not vented to atmosphere.		

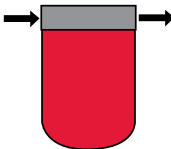
MF 90		Filter Type	Spin-On Single Element <i>(available in BSPP ports)</i>	Flow Path
	Maximum Pressure psi (bar)	250 (17)		
	Maximum Flow gpm (l/min)	15 (57)		
	Port Size Range (in)	3/4 - 1		
	Indicator D = Diff. S = Static	D		
	Filter Model Page	page D54		
	Features	Standard length element. 250 psi rating minimizes leakage in case of flow surges. ΔP sensing indicators. Not available in 3 μm or 25 μm paper elements.		

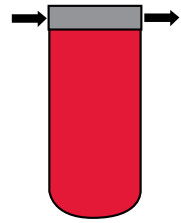

MF 95

	Filter Type	Spin-On Single Element <i>(available in BSPP ports)</i>	Flow Path
	Maximum Pressure psi (bar)	250 (17)	
	Maximum Flow gpm (l/min)	25 (95)	
	Port Size Range (in)	3/4 - 1	
	Indicator D = Diff. S = Static	D	
	Filter Model Page	page D54	
	Features	Extended length element. 250 psi rating minimizes leakage in case of flow surges. Same head as size 90. ΔP sensing indicators. 20 μm Betamicron or 25 μm paper elements not available.	

MFD 160

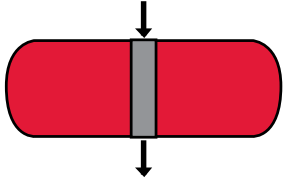
	Filter Type	Spin-On Dual Elements	Flow Path
	Maximum Pressure psi (bar)	120 (8.3)	
	Maximum Flow gpm (l/min)	60 (227)	
	Port Size Range (in)	1 1/2	
	Indicator D = Diff. S = Static	S	
	Filter Model Page	page D54	
Features	Parallel flow through two standard length elements mounted end to end.		

MFDS 160

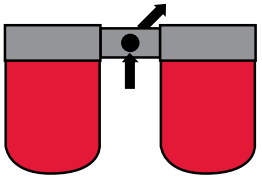
	Filter Type	Spin-On Dual Elements	Flow Path
	Maximum Pressure psi (bar)	120 (8.3)	
	Maximum Flow gpm (l/min)	60 (227)	
	Port Size Range (in)	1 1/2 - 2	
	Indicator D = Diff. S = Static	S	
	Filter Model Page	page D54	
Features	Parallel flow through two standard length elements mounted side by side.		

MFD 180

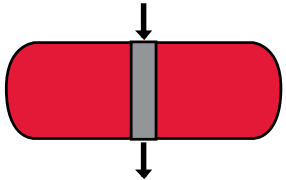
	Filter Type	Spin-On Dual Elements	Flow Path
	Maximum Pressure psi (bar)	120 (8.3)	
	Maximum Flow gpm (l/min)	120 (454)	
	Port Size Range (in)	1 1/2	
	Indicator D = Diff. S = Static	S	
	Filter Model Page	page D54	
Features	Parallel flow through two extended length elements mounted end to end. Same head as MFD 160.		

## MFDS 180



Filter Type	Spin-On Dual Elements
Maximum Pressure psi (bar)	120 (8.3)
Maximum Flow gpm (l/min)	120 (454)
Port Size Range (in)	1 1/2 - 2
Indicator D = Diff. S = Static	S
Filter Model Page	page D54
Features	Parallel flow through two extended length elements mounted side by side. Same head as MFDS 160.

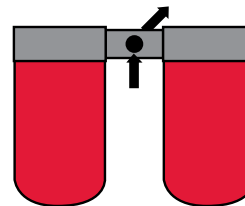

## Medium Pressure Filters

### HF4RL



Filter Type	In-Line
Maximum Pressure psi (bar)	750 (52)
Maximum Flow gpm (l/min)	90 (341)
Port Size Range (in)	1 1/2
Indicator D = Diff. S = Static	D
Filter Model Page	page E2
Features	In-line top loaded simplex filter which meets HF4 automotive, specification requirements and performance.

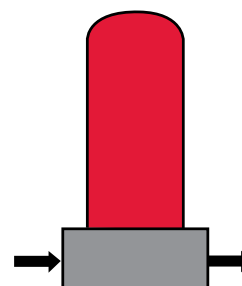

### LPF\*



Filter Type	In-Line
Maximum Pressure psi (bar)	725 (50)
Maximum Flow gpm (l/min)	74 (280)
Port Size Range (in)	1/2 - 1 1/4
Indicator D = Diff. S = Static	D
Filter Model Page	page E6
Features	Multiple uses: pressure lines, returns, off-line loops, and lube lines. Aluminum for low weight and water tolerance.

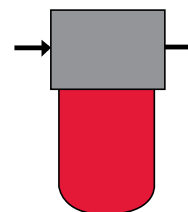

### LF\*



Filter Type	In-Line
Maximum Pressure psi (bar)	1450 (100)
Maximum Flow gpm (l/min)	174 (660)
Port Size Range (in)	1/2 - 1 1/2
Indicator D = Diff. S = Static	D
Filter Model Page	page E12
Features	HYDAC standard filter. Aluminum for low weight and water tolerance.

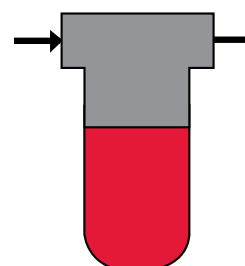

\*For a Set version of this filter, refer to Set Series section of the catalog.

(Click on any filter for more detailed information.)

**LPFH\***

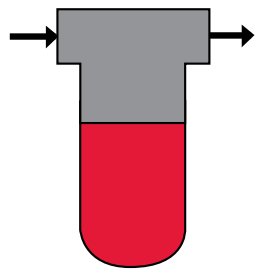
	<b>Filter Type</b>	In-Line	
	<b>Maximum Pressure psi (bar)</b>	500 (34)	
	<b>Maximum Flow gpm (l/min)</b>	112 (425)	
	<b>Port Size Range (in)</b>	1 1/2	
	<b>Indicator D = Diff. S = Static</b>	D	
	<b>Filter Model Page</b>	page E16	
	<b>Features</b>	Cost effective, high performance alternative to spin-on filters with integrated retrofit protection.	

**MFx\***

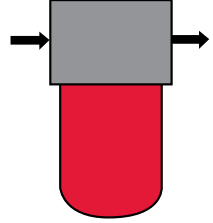
	<b>Filter Type</b>	In-Line	
	<b>Maximum Pressure psi (bar)</b>	725 (50)	
	<b>Maximum Flow gpm (l/min)</b>	35 (130)	
	<b>Port Size Range (in)</b>	3/4 - 1	
	<b>Indicator D = Diff. S = Static</b>	D	
	<b>Filter Model Page</b>	page E20	
	<b>Features</b>	ECO-friendly, cost effective high performance alternative to spin-on filters.	

**High Pressure Filters**

**DF/DFx\***

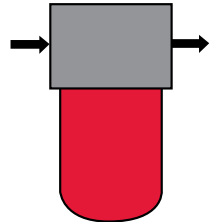
	<b>Filter Type</b>	In-Line	
	<b>Maximum Pressure psi (bar)</b>	6090 (420)	
	<b>Maximum Flow gpm (l/min)</b>	200 (757)	
	<b>Port Size Range (in)</b>	1/2 - 2	
	<b>Indicator D = Diff. S = Static</b>	D	
	<b>Filter Model Page</b>	page F2	
	<b>Features</b>	HYDAC standard high pressure filter. Wide choice of models and elements, and optional features.	

**DF/DFx 1500**

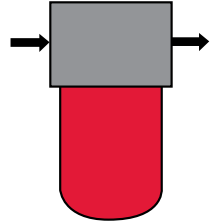
	<b>Filter Type</b>	In-Line	
	<b>Maximum Pressure psi (bar)</b>	6090* / 4060 (420 / 280)	
	<b>Maximum Flow gpm (l/min)</b>	250 (946)	
	<b>Port Size Range (in)</b>	2	
	<b>Indicator D = Diff. S = Static</b>	D	
	<b>Filter Model Page</b>	page F10	
	<b>Features</b>	HYDAC high pressure filter, available in bi-directional and single-flow configurations.  *Good to 300,000 cycles.	

\*For a Set version of this filter, refer to Set Series section of the catalog.

**DFFX SPECIAL ORDER FILTER - Minimum order quantities and/or extended lead times will apply (consult HYDAC Product Management)**

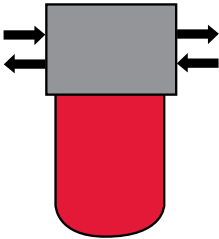
	<b>Filter Type</b>	In-Line	<b>Flow Path</b>
	<b>Maximum Pressure psi (bar)</b>	6090 (420)	
	<b>Maximum Flow gpm (l/min)</b>	160 (606)	
	<b>Port Size Range (in)</b>	2	
	<b>Indicator</b> D = Diff. S = Static	D	
	<b>Filter Model Page</b>	page H80	
	<b>Features</b>	In-line high flow $\Delta P$ optimized forward and reverse flow high pressure filter. High Flow and low differential pressure are prominent features.	

**HDF SPECIAL ORDER FILTER - Minimum order quantities and/or extended lead times will apply (consult HYDAC Product Management)**

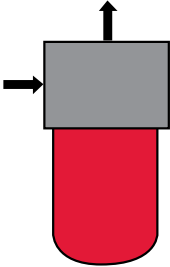
	<b>Filter Type</b>	In-Line	<b>Flow Path</b>
	<b>Maximum Pressure psi (bar)</b>	4060 (280)	
	<b>Maximum Flow gpm (l/min)</b>	100 (378.5)	
	<b>Port Size Range (in)</b>	1 - 1 1/2	
	<b>Indicator</b> D = Diff. S = Static	D	
	<b>Filter Model Page</b>	page H88	
	<b>Features</b>	In-line forward and reverse flow capable "L" ported, high pressure filter which utilizes competitive "9600" geometry filter elements. Available with and without bypass valves. Low and high collapse elements available.	

**HF2P**

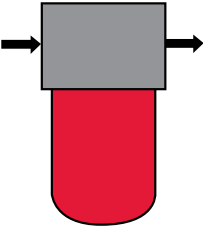
	<b>Filter Type</b>	In-Line	<b>Flow Path</b>
	<b>Maximum Pressure psi (bar)</b>	4000 (276)	
	<b>Maximum Flow gpm (l/min)</b>	25 (95)	
	<b>Port Size Range (in)</b>	3/4	
	<b>Indicator</b> D = Diff. S w= Static	D	
	<b>Filter Model Page</b>	page F18	
	<b>Features</b>	Meets HF2 automotive specifications and uses industry standard-size elements. In-line configuration.	

**HF3P**

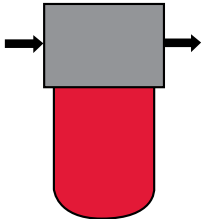
	<b>Filter Type</b>	In-Line	<b>Flow Path</b>
	<b>Maximum Pressure psi (bar)</b>	6090 (420)	
	<b>Maximum Flow gpm (l/min)</b>	120 (454)	
	<b>Port Size Range (in)</b>	1 - 2	
	<b>Indicator</b> D = Diff. S = Static	D	
	<b>Filter Model Page</b>	page F24	
	<b>Features</b>	Meets HF3 automotive specifications and uses industry standard-size elements. In-line configuration.	

(Click on any filter for more detailed information.)

## HF4P



Filter Type	In-Line
Maximum Pressure psi (bar)	5000 (345)
Maximum Flow gpm (l/min)	120 (454)
Port Size Range (in)	1 1/2
Indicator D = Diff. S = Static	D
Filter Model Page	page F28
Features	Meets HF4 automotive specifications and uses industry standard-size elements. Top loading in-line configuration.

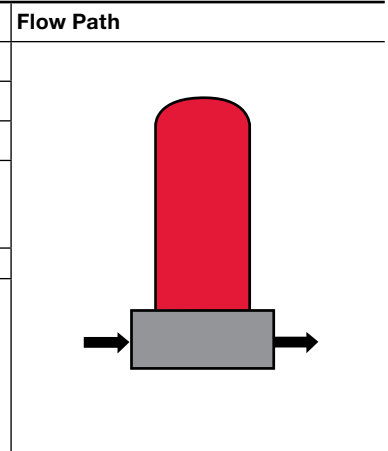

## MFM\*



Filter Type	In-Line
Maximum Pressure psi (bar)	4060 (280)
Maximum Flow gpm (l/min)	25 (95)
Port Size Range (in)	3/4
Indicator D = Diff. S = Static	D
Filter Model Page	page F34
Features	Low cost in-line high pressure filter (efficient design and construction).

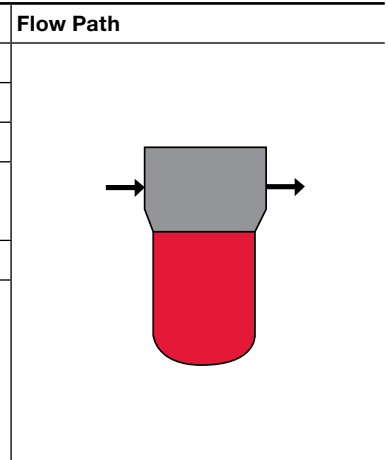

## HFM



Filter Type	In-Line
Maximum Pressure psi (bar)	5800 (400)
Maximum Flow gpm (l/min)	37 (140)
Port Size Range (in)	1
Indicator D = Diff. S = Static	D
Filter Model Page	page F40
Features	In-line high pressure filter.

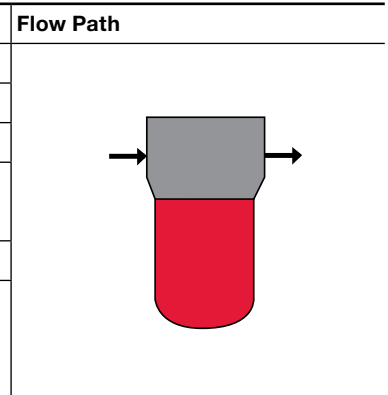

## DF...QE



Filter Type	Manifold Mount
Maximum Pressure psi (bar)	4568 (315)
Maximum Flow gpm (l/min)	110 (416.4)
Port Size Range (in)	0.551 - 1.181
Indicator D = Diff. S = Static	D
Filter Model Page	page F64
Features	Side mount to manifold; upper inlet, lower outlet. Size (30-280). Lower inlet, upper outlet sizes ≥ 330.

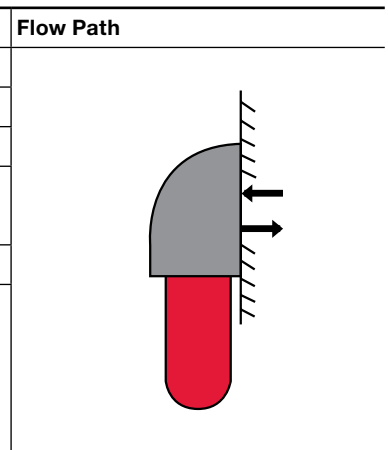

\*For a Set version of this filter, refer to Set Series section of the catalog.

## DFP



Filter Type	Manifold Mount	Flow Path
Maximum Pressure psi (bar)	4568 (315)	
Maximum Flow gpm (l/min)	125 (473)	
Port Size Range (in)	0.689 - 1.181	
Indicator D = Diff. S = Static	D	
Filter Model Page	page F70	
Features	HYDAC standard manifold filter. Ports at top.	

## HF2-P



Filter Type	Manifold Mount	Flow Path
Maximum Pressure psi (bar)	4000 (276)	
Maximum Flow gpm (l/min)	25 (95)	
Port Size Range (in)	0.689	
Indicator D = Diff. S = Static	D	
Filter Model Page	page F18	
Features	Meets HF2 automotive specifications and uses industry standard-size elements. Manifold configuration.	

## HF4-P



Filter Type	Manifold Mount	Flow Path
Maximum Pressure psi (bar)	5000 (345)	
Maximum Flow gpm (l/min)	120 (454)	
Port Size Range (in)	1.25	
Indicator D = Diff. S = Static	D	
Filter Model Page	page F28	
Features	Meets HF4 automotive specifications and uses industry standard-size elements. Manifold configuration.	

## CF



Filter Type	Manifold Cartridge	Flow Path
Maximum Pressure psi (bar)	3000 (207)	
Maximum Flow gpm (l/min)	25 (95)	
Port Size Range (in)	1 SAE-16, (1 1/4) SAE-20	
Indicator D = Diff. S = Static	NA	
Filter Model Page	page F82	
Features	Disposable, high pressure manifold cartridge filter. Low weight, water-tolerant aluminum alloy.	

(Click on any filter for more detailed information.)

## CP-C16



Filter Type	Manifold Cartridge	Flow Path
Maximum Pressure psi (bar)	3000 (207)	
Maximum Flow gpm (l/min)	12 (45)	
Port Size Range (in)	(1) SAE-16	
Indicator D = Diff. S = Static	NA	
Filter Model Page	page F86	
Features	Circuit protector, high pressure manifold cartridge filter. Back-up protection for upstream pressure filters. Fits into standard C16-2 manifold port.	

## CP-SAE



Filter Type	Manifold Cartridge	Flow Path
Maximum Pressure psi (bar)	6090 (420)	
Maximum Flow gpm (l/min)	30 (113)	
Port Size Range (in)	(5/8) SAE-10, (1) SAE-16, (1 1/2) SAE-24	
Indicator D = Diff. S = Static	NA	
Filter Model Page	page F90	
Features	Circuit protector, high pressure manifold cartridge filter. Back-up protection for upstream pressure filters. Fits into standard SAE o-ring port.	

## DFZ



Filter Type	Modular Stacking In-line	Flow Path
Maximum Pressure psi (bar)	4568 (315)	
Maximum Flow gpm (l/min)	10 (38)	
Port Size Range (in)	D03/D05 Patterns (0.25 / 0.44)	
Indicator D = Diff. S = Static	D	
Filter Model Page	page F76	
Features	Cartridge valve sandwich mount. Bowl on right side (standard) or left (optional).	

## FMND



Filter Type	Duplex	Flow Path
Maximum Pressure psi (bar)	3045 (210)	
Maximum Flow gpm (l/min)	106 (400)	
Port Size Range (in)	1 1/4 - 1 1/2	
Indicator D = Diff. S = Static	D	
Filter Model Page	page F44	
Features	HYDAC standard DIN duplex high pressure filter. Right to left flow option available.	

## DFDK



<b>Filter Type</b>	Duplex
<b>Maximum Pressure psi (bar)</b>	4568 (315)
<b>Maximum Flow gpm (l/min)</b>	90 (340)
<b>Port Size Range (in)</b>	3/4 - 2
<b>Indicator</b> D = Diff. S = Static	D
<b>Filter Model Page</b>	page F48
<b>Features</b>	HYDAC standard industrial duplex for continuously operating systems.

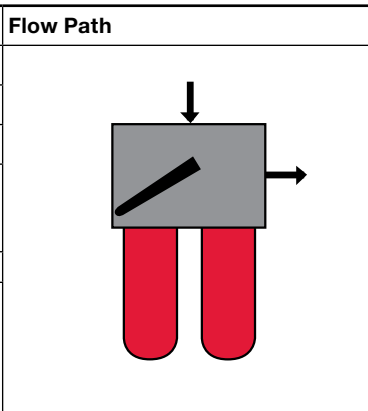

## HFDK4P SPECIAL ORDER FILTER - Minimum order quantities and/or extended lead times will apply (consult HYDAC Product Management)



<b>Filter Type</b>	Duplex
<b>Maximum Pressure psi (bar)</b>	4568 (315)
<b>Maximum Flow gpm (l/min)</b>	90 (340)
<b>Port Size Range (in)</b>	2
<b>Indicator</b> D = Diff. S = Static	D
<b>Filter Model Page</b>	page H92
<b>Features</b>	Meets automotive specifications and uses HF4 standard-size elements. Top loading duplex configuration.

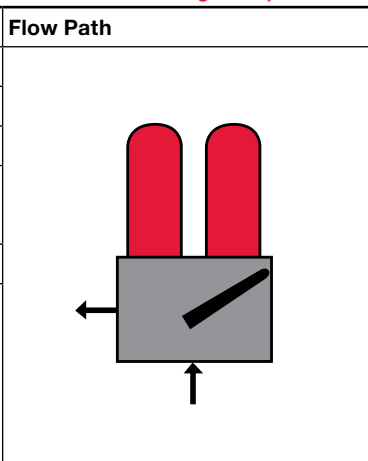

## HFDK3P SPECIAL ORDER FILTER - Minimum order quantities and/or extended lead times will apply (consult HYDAC Product Management)



<b>Filter Type</b>	Duplex
<b>Maximum Pressure psi (bar)</b>	4568 (315)
<b>Maximum Flow gpm (l/min)</b>	90 (340)
<b>Port Size Range (in)</b>	2
<b>Indicator</b> D = Diff. S = Static	D
<b>Filter Model Page</b>	page H96
<b>Features</b>	Specifically designed for the Pulp and Paper market.

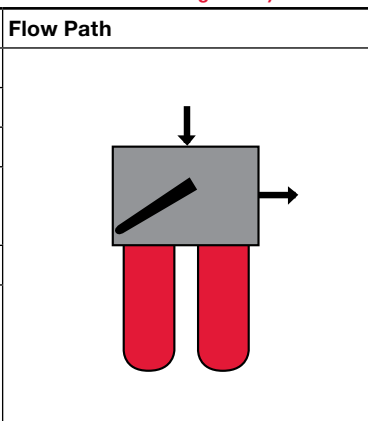





# Can You Spot The Difference?

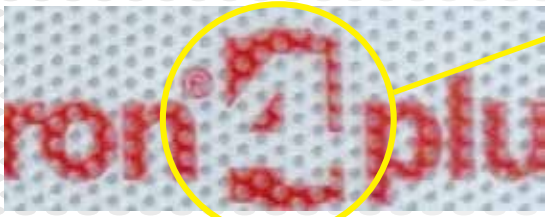

HYDAC element

The frame of the “4” in the replica element is rectangular, whereas in the wrap which is used by HYDAC, the frame of the “4” is designed in the form of a filter element.

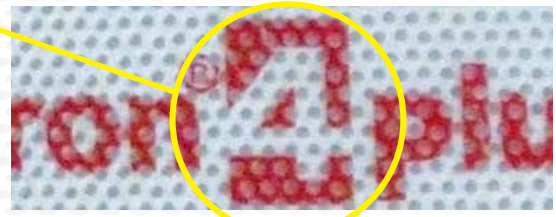

Replica element

Buy Only Genuine



HYDAC multi-layer mesh-pack design with ultrasonic welded seam.

## How to Spot the Difference

Here, notice the difference in the outer wrap: the perforation pattern and the red border around the “4”. Not visible, the pirated element had less filtration layers of lower quality and a glued seam (a HYDAC seam is typically welded). In addition, the end cap identification was inkjet printed (a genuine HYDAC element is laser etched) and the dates on the end cap and its packaging did not match. Last, subtle misspellings were noticed (Beta**r**nicron instead of Beta**m**icron and design**e**d instead of design**i**ng).

It seems that everyone is in the replacement element business, but “Buyer Beware!”. There are suppliers—pirates—who have no concern for quality. Their mission is simply to capitalize on a brand’s reputation for quality engineering. Pirates will offer rock bottom prices, but remember: design differences result in performance differences. Keep in mind that “you get what you pay for”. Don’t end up paying the ultimate price – component failure, production down time and costly repair - by using a cheap, imitation, low-performing element.

The housing pictured right shows evidence of competitor element failure—bypass springs and pieces of the end cap in the outlet side. Application—gearbox. Using Genuine HYDAC products is imperative for optimal performance.



## Winning the War

HYDAC has introduced a new outer wrap design to further differentiate our elements. This exclusive outer wrap both improves performance and provides you quality protection. It features a unique oval-shaped perforation that improves diffusion flow. This is a one-of-a-kind design, so if your element includes this feature, you are assured it is a HYDAC quality original and not an imitation. It is standard on all HYDAC elements.

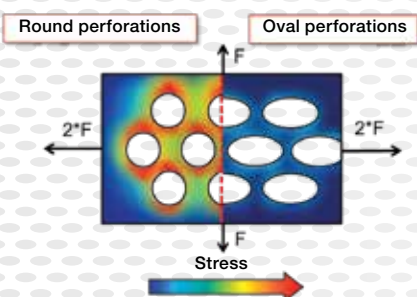

Identifying Genuine **HYDAC** could mean the difference between Success and Failure!

# Ordering HYDAC Literature...

HYDAC literature is available for ordering via our website, [www.hydac-na.com](http://www.hydac-na.com) then click on the **Downloads** button to proceed with ordering printed copies *(digital versions excluded)* or email us at [HYD.catalog@hydac-na.com](mailto:HYD.catalog@hydac-na.com) using the appropriate Part Number (PN) and name. Other brochures, manuals and technical documents are also available when ordering from our website.



Overview Brochure  
PN02088157



Filters Catalog  
PN02081318



Accumulators Catalog  
PN02068195

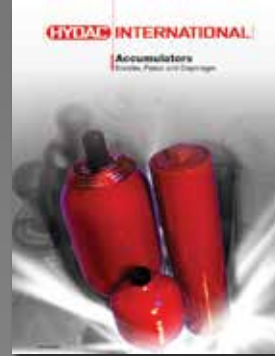

Electronics Catalog\*  
(online only)



Compact Hydraulics  
Catalog - PN02087369

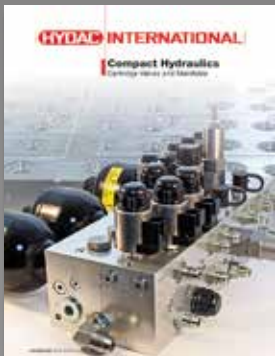

Standard Coolers  
Catalog - PN02085359



Filter Systems Catalog  
PN02075860

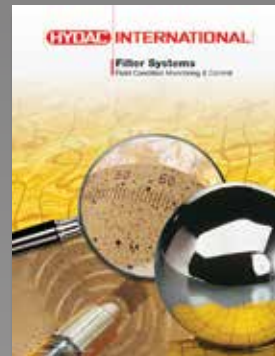

Control Technology\*  
Catalog (online only)



Accessories Catalog  
PN02080105



Mobile Valves Brochure  
PN02092408

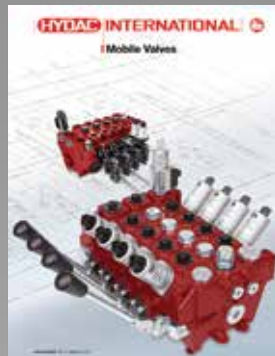

Hydraulic Cylinders  
Brochure (Release: TBD)



Process Technology\*  
Catalog (online only)



\*These catalogs are digital file versions only.

Various market and product brochures are also available for ordering.



**HYDAC TECHNOLOGY CORPORATION**  
**HYDAC CORPORATION**

2260 City Line Road  
Bethlehem, PA 18017

+1.610.266.0100

[HYD.catalog@hydac-na.com](mailto:HYD.catalog@hydac-na.com)  
[www.hydac-na.com](http://www.hydac-na.com)



PN#2211480 / 04.22 / FIL\_1907-2108



# INTERNATIONAL

Global Headquarters  
HYDAC INTERNATIONAL  
GMBH

Industriegebiet  
D – 66280 Sulzbach/Saar  
Germany

Tel.: +49 6897 509-01

Fax: +49 6897 509-577

Internet: [www.hydac.com](http://www.hydac.com)  
Email: [info@hydac.com](mailto:info@hydac.com)

## North America Locations

### USA

[www.HYDAC-NA.com](http://www.HYDAC-NA.com)

**North America Headquarters**  
**HYDAC TECHNOLOGY CORPORATION**  
**Filter Division**  
2260 City Line Road  
Bethlehem, PA 18017  
**+1.610.266.0100**

**HYDAC TECHNOLOGY CORPORATION**  
**Electronic Division**  
**Process Filter Division**  
**HYDAC CORPORATION**  
**Accumulator Division**  
90 Southland Drive  
Bethlehem, PA 18017  
**+1.610.266.0100**

**HYDAC TECHNOLOGY CORPORATION**  
**Accessory Division**  
2204 Avenue C  
Bethlehem, PA 18017  
**+1.610.266.0100**

**HYDAC TECHNOLOGY CORPORATION**  
**Filter System Division**  
**Process Filter Division**  
**Fuel Filtration Division**  
580 West Park Road  
Leetsdale, PA 15056  
**+1.724.318.1100**

**HYDAC TECHNOLOGY CORPORATION**  
**Hydraulic Division –**  
**Compact Hydraulics**  
450 / 445 Windy Point Drive  
Glendale Heights, IL 60139  
**+1.630.545.0800**

**HYDAC TECHNOLOGY CORPORATION**  
**Hydraulic Division – Tech Center**  
430 Windy Point Drive  
Glendale Heights, IL 60139  
**+1.630.545.0800**

**HYDAC TECHNOLOGY CORPORATION**  
**Cooling System Division**  
1051 Airlie Parkway  
Denver, NC 28037  
**+1.610.266.0100**

**HYDAC TECHNOLOGY CORPORATION**  
**Mobile Hydraulic Division**  
4265 East Lincoln Way • Bldg. C  
Wooster, OH 44691  
**+1.610.266.0100**

**HYDAC CYLINDERS LLC**  
540 Carson Road North  
Birmingham, AL 35217  
**+1.205.520.1220**

**HYDAC TECHNOLOGY CORPORATION**  
**HYDAC CORPORATION**  
**Sales Office & Operations**  
510 Stonegate Drive  
Katy, TX 77494  
**+1.281.579.8100**

**HYDAC TECHNOLOGY CORPORATION**  
**HYDAC CORPORATION**  
**NW Sales Office & Operations**  
1201 NE 144th St. Bldg. B • Suite 111  
Vancouver, WA 98685  
**+1.610.266.0100**

**HYDAC TECHNOLOGY CORPORATION**  
**HYDAC CORPORATION**  
**NE Sales Office**  
4265 East Lincoln Way • Bldg. C  
Wooster, OH 44691  
**+1.610.266.0100**

**HYDAC TECHNOLOGY CORPORATION**  
**HYDAC CORPORATION**  
**SE Sales Office**  
1051 Airlie Parkway  
Denver, NC 28037  
**+1.610.266.0100**

**HYDAC TECHNOLOGY CORPORATION**  
**HYDAC CORPORATION**  
**NC Sales Office**  
5307 South 92nd Street • Suite 225  
Hales Corners, WI 53130  
**+1.610.266.0100**

### Canada

[www.HYDAC-NA.com](http://www.HYDAC-NA.com)

**HYDAC CORPORATION**  
14 Federal Road  
Welland, Ontario, Canada L3B 3P2  
**+1.905.714.9322**

**HYDAC CORPORATION**  
**Sales Office**  
5160 75 Street NW  
Edmonton, Alberta, Canada T6E 6W2  
**+1.780.484.4228**

**HYDAC CORPORATION**  
**Sales Office**  
Montreal, Québec, Canada J2M 1K9  
**+1.877.539.3388**

### Mexico

[www.HYDACmex.com](http://www.HYDACmex.com)

**HYDAC INTERNATIONAL SA de CV**  
Calle Alfredo A Nobel No 35  
Col Puente de Vigas  
Tlalnepantla, Edo Mexico  
CP 54090  
Mexico  
**+011.52.55.4777.1262**